



BALDWIN[®]
RESERVE[™]

TECHNICAL SPECIFICATIONS
AND PRICE LIST MAY 2017

BALDWIN®

Baldwin is much more than a timeless and trustworthy brand that creates a charismatic presence in any home.

Baldwin is about creating a signature look that seamlessly blends hardware with the personality of its owner.

No limits. No boundaries. There is a way for every home to “OWN IT” with Baldwin.

ESTATE™

CREATE YOUR SIGNATURE LOOK

RESERVE™

OPENS THE DOOR TO CUSTOMIZATION TO
LEAVE A LASTING IMPRESSION

Prestige Series™

AFFORDABLE LUXURY



FINISHES

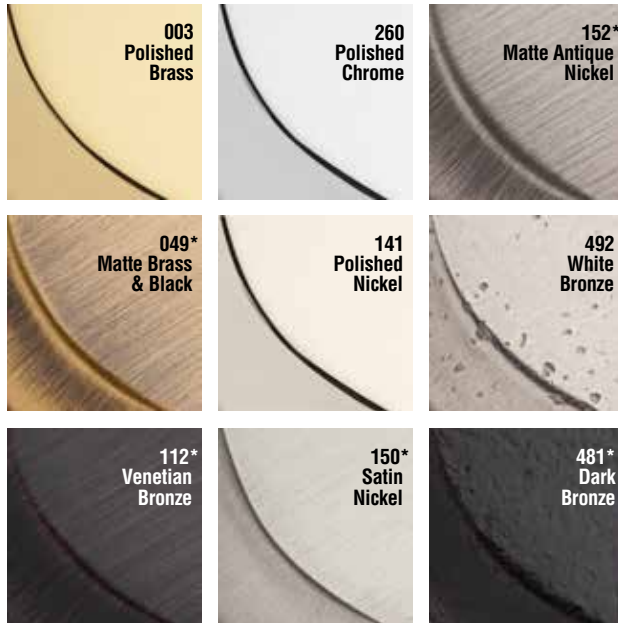

Baldwin Reserve offers nine hand-crafted finishes to customize the look of your hardware

Backed by an industry leading limited 25-year finish warranty

Matte versions of popular Baldwin Estate™ finishes including Matte Brass & Black (049) and Matte Antique Nickel (152)

Two Baldwin finishes, exclusively developed for Reserve; Dark Bronze (481) and White Bronze (492). These finishes replicate a sand cast look but are manufactured with a durable lacquer finishing process.

*HAND-RELIEVED FINISH VARIANCES: (049, 112, 150, 152, 481)

Product finishes which are HAND-RELIEVED may vary in luster, hue, and appearance as a result of handcrafted variances in the final finishing step.

WARRANTY

LIMITED LIFETIME MECHANICAL WARRANTY

Except as limited below, Baldwin Hardware warrants to the original residential purchaser that each Baldwin Reserve product shall be free of mechanical defect for as long as the Purchaser occupies the residential premises upon which the product was originally installed.

LIMITED 25-YEAR FINISH WARRANTY

Limited Finish Warranty: The finish on Baldwin products (excluding Lifetime PVD Finish and living finish products) is protected by a durable topcoat designed to maintain the beauty and quality of the Baldwin product. Except as limited below, Baldwin Hardware warrants to the Purchaser that the finish on each Baldwin Reserve product shall not corrode, tarnish or discolor for 25 years from the original date of purchase.

This warranty DOES NOT COVER scratches; abrasions; or deterioration due to the use of paints, solvents, or other chemicals; abuse; damage from improper installation, misuse; product(s) used in commercial applications and/or any labor required to remove or replace the product under warranty. The warranty is limited to Purchasers who occupy the residential premises upon which the product was originally installed. Proof of purchase required. Refer to www.baldwinhardware.com for a complete warranty statement.

TABLE OF CONTENTS

OVERVIEW

Baldwin	2
Finishes & Warranty	3
Table of Contents	4
Reserve	5

PRODUCT OVERVIEW

Traditional	7
Contemporary	8
Rustic	9

HOW TO ORDER

Handlesets	10-11
Deadbolts	10-11
Knobs	10-11
Levers	10-11

PRODUCT CATALOG

Handlesets	12-17
Deadbolts	18-19
Knobs	20-21
Levers	22-24
Accessories	26-29
Hinges	30

PRODUCT DETAILS

Functions & Handing	31
Door Thickness	31
Latches & Fronts	32
Strikes	32
Cylinders	33
Keying	33
Dimensions & Specifications	34-37

SERVICE PARTS

Keys & Cylinders	38-39
Latches & Fronts	40
Strikes & Screwpacks	41
Misc. Parts	42
Thick Door Kits	43
Deadbolt Interior	43

ORDER SUBMISSION

Terms & Conditions	44
Portfolio Comparison	45
Order Options	46
Style & Finish Codes	47



RESERVE™

The Reserve portfolio is for people who want more. They're looking for more ways to express themselves with the distinctive look of Baldwin and find value in a company with more years of experience and a bona fide commitment to quality. Far beyond just a lock in a box, Reserve opens the door to a customizable world flowing with inspiration. And it's all ready to go whenever inspiration strikes because its ready to ship in just 7 days. And with free shipping on all orders, you will receive your products in 3 days or less, anywhere in the continental United States. Reserve is the best of both worlds—accessibility and artful appeal. Leave a lasting impression with Baldwin Reserve.





New Hampshire Handleset in Polished Chrome finish.



Chesapeake
(CHE)



Columbus
(COL)



Del Mar
(DEL)



Elizabeth
(ELI)



Napa
(NAP)



New Hampshire
(NEW)



Westcliff
(WES)



Crystal (CRY)
Shown with Traditional
Square Rose



Ellipse (ELL)
Shown with Traditional
Round Rose



Round (ROU)
Shown with Traditional
Square Rose



Traditional (TRA)
Shown with Traditional
Arch Rose



Traditional Round
Deadbolt (TRD)



Traditional Square
Deadbolt (TSD)



Traditional Arch
Deadbolt (TAD)



Curve (CUR)
Shown with Traditional
Round Rose



Decorative (DEC)
Shown with Traditional
Arch Rose



Federal (FED)
Shown with Traditional
Square Rose



S
Knocker



Contemporary
Knocker



Ring
Knocker



Rectangular
Bell Button



Oval
Bell Button



Arch
Bell Button



Crystal Knob shown in a variety of finishes.

TRADITIONAL FINISHES AVAILABLE



003
Polished
Brass



049
Matte Brass
& Black

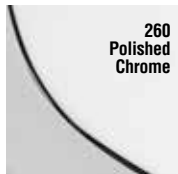

260
Polished
Chrome

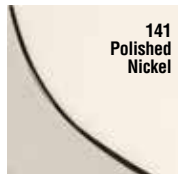

141
Polished
Nickel



150
Satin
Nickel



152
Matte Antique
Nickel



112
Venetian
Bronze

CONTEMPORARY



La Jolla
(LAJ)



Miami
(MIA)



Seattle
(SEA)



Santa Cruz
(SAN)



Contemporary Round
Deadbolt (CRD)



Contemporary Square
Deadbolt (CSD)



Contemporary (CON)
Shown with Contemporary
Square Rose



Tube (TUB)
Shown with Contemporary
Round Rose



Square (SQU)
Shown with Contemporary
Square Rose



Contemporary
Door Knocker



Rectangular
Bell Button



Contemporary Knob with Contemporary Square Rose in Polished Nickel finish.

CONTEMPORARY FINISHES AVAILABLE



260
Polished
Chrome

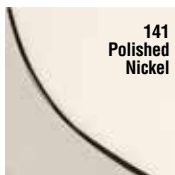

141
Polished
Nickel



150
Satin
Nickel

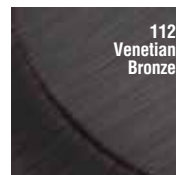

112
Venetian
Bronze



Elkhorn (ELK)



Adirondack (ADI)



Kodiak (KOD)



Longview (LON)



Rustic Arch Deadbolt (RAD)



Rustic Square Deadbolt (RSD)



Taper (TAP)
Shown with Rustic Square Rose



Arch (ARC)
Shown with Rustic Arch Rose



Rustic (RUS)
Shown with Rustic Square Rose



Ring Door Knocker



Arch Bell Button



Longview Handleset in Dark Bronze finish.

RUSTIC FINISHES AVAILABLE



492 White Bronze

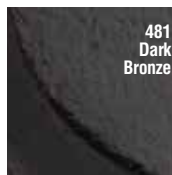

481 Dark Bronze

HOW TO ORDER

HANDLESETS

Example: "I would like two Double Cylinder SmartKey-Elizabeth handlesets keyed alike in venetian bronze finish with the traditional arch rose and decorative lever in satin nickel on the interior. The door is left hand and my door is currently prepared for round corner latches and strikes."

1. Required – Start your order configuration with the following required information:

DC		ELIXDEC			L		TAR		112x150		
Function		Style Exterior X Interior			Handing		Rose		Finish Exterior x Interior		
SC	Single Cylinder	ADI	Adirondack	CON	Contemporary	L	Left	TRR	Trad. Round Rose	<i>Traditional Styles</i>	
DC	Double Cylinder	CHE	Chesapeake	ELL	Ellipse	R	Right	TAR	Trad. Arch Rose	003	Polished Brass
FD	Full Dummy	COL	Columbus	ROU	Round			TSR	Trad. Square Rose	049	Matte Brass & Black
		DEL	Del Mar	RUS	Rustic			CRR	Cont. Round Rose	112	Venetian Bronze
		ELI	Elizabeth	TRA	Traditional			CSR	Cont. Square Rose	150	Satin Nickel
		ELK	Elkhorn	ARC	Arch			RAR	Rustic Arch Rose	152	Matte Antique Nickel
		KOD	Kodiak	CUR	Curve			RSR	Rustic Square Rose	260	Polished Chrome
		LAJ	La Jolla	DEC	Decorative					141	Polished Nickel
		LON	Longview	FED	Federal					<i>Contemporary Styles</i>	
		MIA	Miami	SQU	Square					112	Venetian Bronze
		NAP	Napa	TAP	Taper					150	Satin Nickel
		NEW	New Hampshire	TUB	Tube					260	Polished Chrome
		SAN	Santa Cruz							141	Polished Nickel
		SEA	Seattle							<i>Rustic Styles</i>	
		WES	Westcliff							481	Dark Bronze
										492	White Bronze
							Levers Only				

DEADBOLTS

Example: "I would like a single cylinder traditional round deadbolt in satin nickel finish, but I prefer the traditional arch tumpline instead. The tumpline should be brass color."

1. Required – Start your order configuration with the following required information:

SC		TRDXTAD			150x003	
Function		Style Exterior X Interior			Finish Exterior x Interior	
SC	Single Cylinder	TRD	Traditional Round Deadbolt	<i>Traditional Styles</i>		
DC	Double Cylinder	TAD	Traditional Arch Deadbolt	003	Polished Brass	
PT	Patio	TSD	Traditional Square Deadbolt	049	Matte Brass & Black	
		CRD	Contemporary Round Deadbolt	112	Venetian Bronze	
		GSD	Contemporary Square Deadbolt	150	Satin Nickel	
		RAD	Rustic Arch Deadbolt	152	Matte Antique Nickel	
		RSD	Rustic Square Deadbolt	260	Polished Chrome	
				141	Polished Nickel	
				<i>Contemporary Styles</i>		
				112	Venetian Bronze	
				150	Satin Nickel	
				260	Polished Chrome	
				141	Polished Nickel	
				<i>Rustic Styles</i>		
				481	Dark Bronze	
				492	White Bronze	

KNOBS

Example: "I am looking for the traditional knob with the traditional round rose outside and traditional arch rose inside. I need two privacy knobs. They should all be in satin nickel finish."

1. Required – Start your order configuration with the following required information:

PV		TRA			N/A		TRRXSTAR		150		
Function		Style Exterior X Interior			Handing		Rose Exterior X Interior		Finish Exterior x Interior		
EN	Entry	CON	Contemporary	ARC	Arch	L	Left	TRR	Trad. Round Rose	<i>Traditional Styles</i>	
PS	Passage	CRY	Crystal	CON	Contemporary	R	Right	TAR	Trad. Arch Rose	003	Polished Brass
PV	Privacy	ELL	Ellipse	CRY	Crystal			TSR	Trad. Square Rose	049	Matte Brass & Black
FD	Full Dummy	ROU	Round	CUR	Curve			CRR	Cont. Round Rose	112	Venetian Bronze
HD	Half Dummy	RUS	Rustic	DEC	Decorative			CSR	Cont. Square Rose	150	Satin Nickel
		TRA	Traditional	ELL	Ellipse			RAR	Rustic Arch Rose	152	Matte Antique Nickel
				FED	Federal			RSR	Rustic Square Rose	260	Polished Chrome
				ROU	Round					141	Polished Nickel
				RUS	Rustic					<i>Contemporary Styles</i>	
				SQU	Square					112	Venetian Bronze
				TAP	Taper					150	Satin Nickel
				TRA	Traditional					260	Polished Chrome
				TUB	Tube					141	Polished Nickel
							When ordering with lever interior			<i>Rustic Styles</i>	
										481	Dark Bronze
										492	White Bronze

LEVERS

Example: "I would like an entry tube lever with contemporary round rose with 150 exterior and 260 interior. The door is right hand and currently prepared for round corner latches and strikes."

1. Required – Start your order configuration with the following required information:

EN		TUB			R		CRR		150x260		
Function		Style Exterior X Interior			Handing		Rose Exterior X Interior		Finish Exterior x Interior		
EN	Entry	ARC	Arch	ARC	Arch	L	Left	TRR	Trad. Round Rose	<i>Traditional Styles</i>	
PS	Passage	CUR	Curve	CON	Contemporary	R	Right	TAR	Trad. Arch Rose	003	Polished Brass
PV	Privacy	DEC	Decorative	CRY	Crystal			TSR	Trad. Square Rose	049	Matte Brass & Black
FD	Full Dummy	FED	Federal	CUR	Curve			CRR	Cont. Round Rose	112	Venetian Bronze
HD	Half Dummy	SQU	Square	DEC	Decorative			CSR	Cont. Square Rose	150	Satin Nickel
		TAP	Taper	ELL	Ellipse			RAR	Rustic Arch Rose	152	Matte Antique Nickel
		TUB	Tube	FED	Federal			RSR	Rustic Square Rose	260	Polished Chrome
				ROU	Round					141	Polished Nickel
				RUS	Rustic					<i>Contemporary Styles</i>	
				SQU	Square					112	Venetian Bronze
				TAP	Taper					150	Satin Nickel
				TRA	Traditional					260	Polished Chrome
				TUB	Tube					141	Polished Nickel
							When ordering split style, split finish, or half dummy			<i>Rustic Styles</i>	
										481	Dark Bronze
										492	White Bronze

HANDLESETS

2. Options – Add additional customization with the following optional features:

STD		RL		RS		SMT		K2	
Door Thickness		Latch		Strike		Cylinder		Keying	
STD	1.75" to 2" Doors*	SL	Square Corner Latch*	SS	Square Corner Strike*	CKY	C-Keyway Pin & Tumbler*	KD	Keyed Different*
THK	2" to 2.5" Doors	RL	Round Corner Latch	RS	Round Corner Strike	SMT	SmartKey	KA	Keyed Alike (A=#)
THN	1.375" to 1.75" Doors**	DL	Drive In Latch	DS	Dual Strike Kit			CK	Construction Key
		6L	6 Way Latch					KC	Key Code
		SLUL	Square Corner UL Latch					MK	Master Key
		RLUL	Round Corner UL Latch					WITH	Separate Lines Keyed Together
		DLUL	Drive In Corner UL Latch						

NOTES

- Handing only required when ordering with lever interior style and is always measured from the exterior of the door.
- Rose style will determine interior deadbolt turnpiece style.
- Dummy handlesets use a Single Cylinder interior style (with non-functioning turnpiece)
- Indicate exterior x interior finish when ordering split finishes - if single finish, specify only once.

OPTIONS NOTES

*Orders will ship with default options in bold unless otherwise specified.

**Available with Napa and Westcliff styles, SC and DC.

DEADBOLTS

2. Options – Add additional customization with the following optional features:

STD		SL		SS		CKY		N/A	
Door Thickness		Latch		Strike		Cylinder		Keying	
STD	1.75" to 2" Doors*	SL	Square Corner Latch*	SS	Square Corner Strike*	CKY	C-Keyway Pin & Tumbler*	KD	Keyed Different*
THK	2" to 2.5" Doors	RL	Round Corner Latch	RS	Round Corner Strike	SMT	SmartKey	KA	Keyed Alike (A=#)
THN	1.375" to 1.75" Doors**	DL	Drive In Latch	DS	Dual Strike Kit			CK	Construction Key
		6L	6 Way Latch	FS	Full Lip Deadbolt Strike			KC	Key Code
		SLUL	Square Corner UL Latch					MK	Master Key
		RLUL	Round Corner UL Latch					WITH	Separate Lines Keyed Together
		DLUL	Drive In Corner UL Latch						

NOTES

- Indicate exterior x interior style or finish when ordering split styles or finishes - if single style or finish, specify only once.

OPTIONS NOTES

*Orders will ship with default options in bold unless otherwise specified.

**Available with Traditional and Contemporary styles, SC and DC.

KNOBS

2. Options – Add additional customization with the following optional features:

STD		SL		SS		N/A	
Door Thickness		Latch		Strike		Keying	
STD	1.375" to 2" Doors*	SL	Square Corner Latch*	SS	Square Corner Strike*	KD	Keyed Different*
THK	2" to 2.5" Doors	RL	Round Corner Latch	RS	Round Corner Strike	KA	Keyed Alike (A=#)
		DL	Drive In Latch	DS	Dual Strike Kit	CK	Construction Key
		6L	6 Way Latch			KC	Key Code
		SLUL	Square Corner UL Latch			MK	Master Key
		RLUL	Round Corner UL Latch			WITH	Separate Lines Keyed Together
		DLUL	Drive In Corner UL Latch				

NOTES

- Handing only required when ordering with lever interior style and is always measured from the exterior of the door.
- Indicate exterior x interior style, rose, or finish when ordering split styles, roses, or finishes - if single style, rose, or finish, specify only once.

OPTIONS NOTES

*Orders will ship with default options in bold unless otherwise specified.

Available with C-Keyway cylinder only.

LEVERS

2. Options – Add additional customization with the following optional features:

STD		RL		RS		KD	
Door Thickness		Latch		Strike		Keying	
STD	1.375" to 2" Doors*	SL	Square Corner Latch*	SS	Square Corner Strike*	KD	Keyed Different*
THK	2" to 2.5" Doors	RL	Round Corner Latch	RS	Round Corner Strike	KA	Keyed Alike (A=#)
		DL	Drive In Latch	DS	Dual Strike Kit	CK	Construction Key
		6L	6 Way Latch			KC	Key Code
		SLUL	Square Corner UL Latch			MK	Master Key
		RLUL	Round Corner UL Latch			WITH	Separate Lines Keyed Together
		DLUL	Drive In Corner UL Latch				

NOTES

- Handing required when ordering half dummy function, and with orders that will be split finish, split lever style, or split with a knob. Handing always measured from the exterior of the door.
- Indicate Exterior x Interior style, rose, or finish when ordering split styles, roses, or finishes - if single style, rose, or finish, specify only once.

OPTIONS NOTES

*Orders will ship with default options in bold unless otherwise specified.

Available with C-Keyway cylinder only.

TRADITIONAL HANDLESETS



COL







NAP



WES



CHE

Function	Style	Interior Knob or Lever*	Handing	Interior Rose	Finish	List Price
(SC) Single Cylinder (DC) Double Cylinder (FD) Full Dummy	(COL) Columbus 	(ROU) Round (ELL) Ellipse (TRA) Traditional	N/A	(TRR) Traditional Round Rose (TAR) Traditional Arch Rose (TSR) Traditional Square Rose	(003) Polished Brass (049) Matte Brass & Black (150) Satin Nickel (152) Matte Antique Nickel (112) Venetian Bronze (260) Polished Chrome (141) Polished Nickel	\$275.00
		(CUR) Curve (FED) Federal (DEC) Decorative	(R) Right Hand (L) Left Hand			
(SC) Single Cylinder (DC) Double Cylinder (FD) Full Dummy	(NAP) Napa** 	(ROU) Round (ELL) Ellipse (TRA) Traditional	N/A	(TRR) Traditional Round Rose (TAR) Traditional Arch Rose (TSR) Traditional Square Rose	(003) Polished Brass (049) Matte Brass & Black (150) Satin Nickel (152) Matte Antique Nickel (112) Venetian Bronze (260) Polished Chrome (141) Polished Nickel	\$275.00
		(CUR) Curve (FED) Federal (DEC) Decorative	(R) Right Hand (L) Left Hand			
(SC) Single Cylinder (DC) Double Cylinder (FD) Full Dummy	(WES) Westcliff** 	(ROU) Round (ELL) Ellipse (TRA) Traditional	N/A	(TRR) Traditional Round Rose (TAR) Traditional Arch Rose (TSR) Traditional Square Rose	(003) Polished Brass (049) Matte Brass & Black (150) Satin Nickel (152) Matte Antique Nickel (112) Venetian Bronze (260) Polished Chrome (141) Polished Nickel	\$275.00
		(CUR) Curve (FED) Federal (DEC) Decorative	(R) Right Hand (L) Left Hand			
(SC) Single Cylinder (DC) Double Cylinder (FD) Full Dummy	(CHE) Chesapeake 	(ROU) Round (ELL) Ellipse (TRA) Traditional	N/A	(TRR) Traditional Round Rose (TAR) Traditional Arch Rose (TSR) Traditional Square Rose	(003) Polished Brass (049) Matte Brass & Black (150) Satin Nickel (152) Matte Antique Nickel (112) Venetian Bronze (260) Polished Chrome (141) Polished Nickel	\$310.00
		(CUR) Curve (FED) Federal (DEC) Decorative	(R) Right Hand (L) Left Hand			

Additional interior styles available, depending on interior finish.





*Crystal knob not available with handleset interior.

**Thin door option available for 1.375" to 1.75" Single Cylinder and Double Cylinder.

HOW TO ORDER: FUNCTION.STYLE.HANDING.ROSE.FINISH

TRADITIONAL HANDLESETS



Function	Style	Interior Knob or Lever*	Handing	Interior Rose	Finish	List Price	
(SC) Single Cylinder (DC) Double Cylinder (FD) Full Dummy	(DEL) Del Mar 	(ROU) Round	N/A	(TRR) Traditional Round Rose (TAR) Traditional Arch Rose (TSR) Traditional Square Rose	(003) Polished Brass	\$310.00	
		(ELL) Ellipse			(R) Right Hand (L) Left Hand		(049) Matte Brass & Black
		(TRA) Traditional					(150) Satin Nickel
(SC) Single Cylinder (DC) Double Cylinder (FD) Full Dummy	(ELI) Elizabeth 	(ROU) Round	N/A	(TRR) Traditional Round Rose (TAR) Traditional Arch Rose (TSR) Traditional Square Rose	(003) Polished Brass	\$310.00	
		(ELL) Ellipse			(R) Right Hand (L) Left Hand		(049) Matte Brass & Black
		(TRA) Traditional					(150) Satin Nickel
(SC) Single Cylinder (DC) Double Cylinder (FD) Full Dummy	(NEW) New Hampshire 	(ROU) Round	N/A	(TRR) Traditional Round Rose (TAR) Traditional Arch Rose (TSR) Traditional Square Rose	(003) Polished Brass	\$310.00	
		(ELL) Ellipse			(R) Right Hand (L) Left Hand		(049) Matte Brass & Black
		(TRA) Traditional					(150) Satin Nickel
(SC) Single Cylinder (DC) Double Cylinder (FD) Full Dummy	(NEW) New Hampshire 	(CUR) Curve	(R) Right Hand (L) Left Hand	(TRR) Traditional Round Rose (TAR) Traditional Arch Rose (TSR) Traditional Square Rose	(152) Matte Antique Nickel	\$310.00	
		(FED) Federal			(112) Venetian Bronze		
		(DEC) Decorative			(260) Polished Chrome		
(SC) Single Cylinder (DC) Double Cylinder (FD) Full Dummy	(NEW) New Hampshire 	(CUR) Curve	(R) Right Hand (L) Left Hand	(TRR) Traditional Round Rose (TAR) Traditional Arch Rose (TSR) Traditional Square Rose	(141) Polished Nickel	\$310.00	
		(FED) Federal			(112) Venetian Bronze		
		(DEC) Decorative			(260) Polished Chrome		

Additional interior styles available, depending on interior finish.

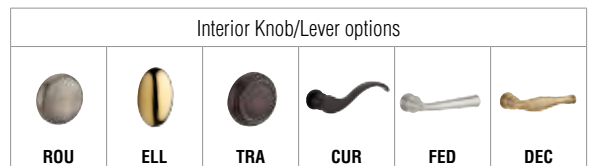
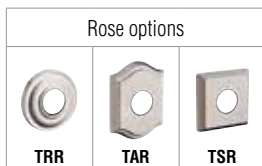

*Crystal knob not available with handleset interior.

HOW TO ORDER: FUNCTION.STYLE.HANDING.ROSE.FINISH



Santa Cruz Handleset in Polished Nickel finish.

CONTEMPORARY HANDLESETS



LAJ



MIA



SEA



SAN

Function	Style	Interior Knob or Lever	Handing	Interior Rose	Finish	List Price
(SC) Single Cylinder (DC) Double Cylinder (FD) Full Dummy	(LAJ) La Jolla 	(CON) Contemporary	N/A	(CRR) Contemporary Round Rose	(150) Satin Nickel (112) Venetian Bronze	\$275.00
		(TUB) Tube	(R) Right Hand (L) Left Hand	(CSR) Contemporary Square Rose	(260) Polished Chrome (141) Polished Nickel	
		(SQU) Square				
(SC) Single Cylinder (DC) Double Cylinder (FD) Full Dummy	(MIA) Miami 	(CON) Contemporary	N/A	(CRR) Contemporary Round Rose	(150) Satin Nickel (112) Venetian Bronze	\$310.00
		(TUB) Tube	(R) Right Hand (L) Left Hand	(CSR) Contemporary Square Rose	(260) Polished Chrome (141) Polished Nickel	
		(SQU) Square				
(SC) Single Cylinder (DC) Double Cylinder (FD) Full Dummy	(SEA) Seattle 	(CON) Contemporary	N/A	(CRR) Contemporary Round Rose	(150) Satin Nickel (112) Venetian Bronze	\$310.00
		(TUB) Tube	(R) Right Hand (L) Left Hand	(CSR) Contemporary Square Rose	(260) Polished Chrome (141) Polished Nickel	
		(SQU) Square				
(SC) Single Cylinder (DC) Double Cylinder (FD) Full Dummy	(SAN) Santa Cruz 	(CON) Contemporary	N/A	(CRR) Contemporary Round Rose	(150) Satin Nickel (112) Venetian Bronze	\$370.00
		(TUB) Tube	(R) Right Hand (L) Left Hand	(CSR) Contemporary Square Rose	(260) Polished Chrome (141) Polished Nickel	
		(SQU) Square				

Additional interior styles available, depending on interior finish.

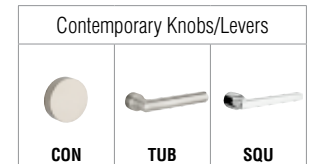
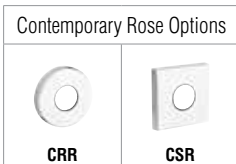

HOW TO ORDER: FUNCTION.STYLE.HANDING.ROSE.FINISH



Elkhorn Handleset in Dark Bronze finish.

RUSTIC HANDLESETS



ADI



KOD



ELK



LON

Function	Style	Interior Knob or Lever	Handing	Interior Rose	Finish	List Price
(SC) Single Cylinder (DC) Double Cylinder (FD) Full Dummy	(ADI) Adirondack 	(RUS) Rustic	N/A	(RAR) Rustic Arch Rose	(481) Dark Bronze	\$350.00
		(ARC) Arch	(R) Right Hand (L) Left Hand	(RSR) Rustic Square Rose	(492) White Bronze	
		(TAP) Taper				
(SC) Single Cylinder (DC) Double Cylinder (FD) Full Dummy	(KOD) Kodiak 	(RUS) Rustic	N/A	(RAR) Rustic Arch Rose	(481) Dark Bronze	\$380.00
		(ARC) Arch	(R) Right Hand (L) Left Hand	(RSR) Rustic Square Rose	(492) White Bronze	
		(TAP) Taper				
(SC) Single Cylinder (DC) Double Cylinder (FD) Full Dummy	(ELK) Elkhorn 	(RUS) Rustic	N/A	(RAR) Rustic Arch Rose	(481) Dark Bronze	\$445.00
		(ARC) Arch	(R) Right Hand (L) Left Hand	(RSR) Rustic Square Rose	(492) White Bronze	
		(TAP) Taper				
(SC) Single Cylinder (DC) Double Cylinder (FD) Full Dummy	(LON) Longview 	(RUS) Rustic	N/A	(RAR) Rustic Arch Rose	(481) Dark Bronze	\$445.00
		(ARC) Arch	(R) Right Hand (L) Left Hand	(RSR) Rustic Square Rose	(492) White Bronze	
		(TAP) Taper				

Additional interior styles available, depending on interior finish.

Rustic Rose Options



Rustic Knobs/Lever Options



HOW TO ORDER: FUNCTION.STYLE.HANDING.ROSE.FINISH

TRADITIONAL DEADBOLTS



TRD



TAD



TSD

Function	Style	Finish	List Price
	(TRD) Traditional Round Deadbolt*		
(SC) Single Cylinder		(003) Polished Brass	\$65.00
(DC) Double Cylinder		(049) Matte Brass & Black (150) Satin Nickel (152) Matte Antique Nickel (112) Venetian Bronze (260) Polished Chrome	\$70.00
(PT) Patio		(141) Polished Nickel	\$42.00
	(TAD) Traditional Arch Deadbolt*		
(SC) Single Cylinder		(003) Polished Brass	\$65.00
(DC) Double Cylinder		(049) Matte Brass & Black (150) Satin Nickel (152) Matte Antique Nickel (112) Venetian Bronze (260) Polished Chrome	\$70.00
(PT) Patio		(141) Polished Nickel	\$42.00
	(TSD) Traditional Square Deadbolt*		
(SC) Single Cylinder		(003) Polished Brass	\$65.00
(DC) Double Cylinder		(049) Matte Brass & Black (150) Satin Nickel (152) Matte Antique Nickel (112) Venetian Bronze (260) Polished Chrome	\$70.00
(PT) Patio		(141) Polished Nickel	\$42.00

*Thin door option available for 1.375" to 1.75".

HOW TO ORDER: FUNCTION.STYLE.FINISH

CONTEMPORARY & RUSTIC DEADBOLTS



CRD







CSD



RAD



RSD

Function	Style	Finish	List Price
(SC) Single Cylinder	(CRD) Contemporary Round Deadbolt* 	(150) Satin Nickel	\$65.00
(DC) Double Cylinder		(112) Venetian Bronze	\$70.00
(PT) Patio		(260) Polished Chrome (141) Polished Nickel	\$42.00
(SC) Single Cylinder	(CSD) Contemporary Square Deadbolt* 	(150) Satin Nickel	\$65.00
(DC) Double Cylinder		(112) Venetian Bronze	\$70.00
(PT) Patio		(260) Polished Chrome (141) Polished Nickel	\$42.00
(SC) Single Cylinder	(RAD) Rustic Arch Deadbolt** 	(481) Dark Bronze	\$77.00
(DC) Double Cylinder		(492) White Bronze	\$82.00
(PT) Patio			\$44.00
(SC) Single Cylinder	(RSD) Rustic Square Deadbolt** 	(481) Dark Bronze	\$77.00
(DC) Double Cylinder		(492) White Bronze	\$82.00
(PT) Patio			\$44.00

*Thin door option available for 1.375" to 1.75".

**Double cylinder includes swing cover on exterior only. No thin door option available.

HOW TO ORDER: FUNCTION.STYLE.FINISH



CRY.TSR





ELL.TRR



ROU.TSR



Function	Style	Rose	Finish	List Price
(EN) Entry*			(003) Polished Brass	N/A
(PS) Passage	(CRY) Crystal 	(TRR) Traditional Round Rose	(049) Matte Brass & Black	\$135.00
(PV) Privacy		(TAR) Traditional Arch Rose	(150) Satin Nickel	
(FD) Full Dummy		(TSR) Traditional Square Rose	(152) Matte Antique Nickel	
			(112) Venetian Bronze	
(HD) Half Dummy			(260) Polished Chrome	\$67.50
			(141) Polished Nickel	
(EN) Entry			(003) Polished Brass	\$174.00
(PS) Passage	(ELL) Ellipse 	(TRR) Traditional Round Rose	(049) Matte Brass & Black	\$109.00
(PV) Privacy		(TAR) Traditional Arch Rose	(150) Satin Nickel	
(FD) Full Dummy		(TSR) Traditional Square Rose	(152) Matte Antique Nickel	
			(112) Venetian Bronze	
(HD) Half Dummy			(260) Polished Chrome	\$54.50
			(141) Polished Nickel	
(EN) Entry			(003) Polished Brass	\$174.00
(PS) Passage	(ROU) Round 	(TRR) Traditional Round Rose	(049) Matte Brass & Black	\$109.00
(PV) Privacy		(TAR) Traditional Arch Rose	(150) Satin Nickel	
(FD) Full Dummy		(TSR) Traditional Square Rose	(152) Matte Antique Nickel	
			(112) Venetian Bronze	
(HD) Half Dummy			(260) Polished Chrome	\$54.50
			(141) Polished Nickel	

Other roses available, depending on finish.
 Entry knobs and levers available with C-Keyway pin and tumbler cylinder only.

*Entry function not available.





TRA.TAR



CON.CRR



RUS.RSR

Function	Style	Rose	Finish	List Price
(EN) Entry	(TRA) Traditional	(TRR) Traditional Round Rose (TAR) Traditional Arch Rose (TSR) Traditional Square Rose	(003) Polished Brass	\$174.00
(PS) Passage			(049) Matte Brass & Black	\$109.00
(PV) Privacy			(150) Satin Nickel	
(FD) Full Dummy			(152) Matte Antique Nickel	
(HD) Half Dummy			(112) Venetian Bronze	\$54.50
			(260) Polished Chrome	
			(141) Polished Nickel	
(EN) Entry	(CON) Contemporary	(CRR) Contemporary Round Rose (CSR) Contemporary Square Rose	(150) Satin Nickel	\$182.00
(PS) Passage			(112) Venetian Bronze	\$137.00
(PV) Privacy			(260) Polished Chrome	
(FD) Full Dummy			(141) Polished Nickel	
(HD) Half Dummy				\$68.50
(EN) Entry	(RUS) Rustic	(RAR) Rustic Arch Rose (RSR) Rustic Square Rose	(481) Dark Bronze	\$189.00
(PS) Passage			(492) White Bronze	\$139.00
(PV) Privacy				
(FD) Full Dummy				
(HD) Half Dummy				\$69.50

Other roses available, depending on finish.
Entry knobs and levers available with C-Keyway pin and tumbler cylinder only.

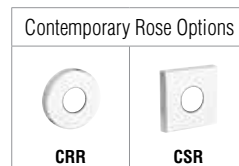

HOW TO ORDER: FUNCTION.STYLE.HANDING.ROSE.FINISH

TRADITIONAL LEVERS



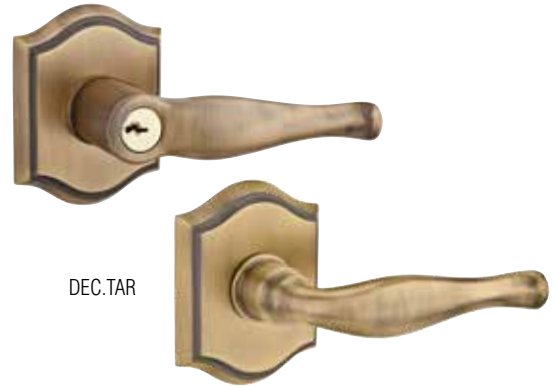

CUR.TRR



DEC.TAR



FED.TSR

Function	Style	Handing	Rose	Finish	List Price
(EN) Entry		(R) Right Hand (L) Left Hand	(TRR) Traditional Round Rose (TAR) Traditional Arch Rose (TSR) Traditional Square Rose	(003) Polished Brass	\$174.00
(PS) Passage				(049) Matte Brass & Black	\$109.00
(PV) Privacy				(150) Satin Nickel	
(FD) Full Dummy				(152) Matte Antique Nickel	
(HD) Half Dummy				(112) Venetian Bronze	\$54.50
				(260) Polished Chrome	
				(141) Polished Nickel	
(EN) Entry		(R) Right Hand* (L) Left Hand*	(TRR) Traditional Round Rose (TAR) Traditional Arch Rose (TSR) Traditional Square Rose	(003) Polished Brass	\$174.00
(PS) Passage				(049) Matte Brass & Black	\$109.00
(PV) Privacy				(150) Satin Nickel	
(FD) Full Dummy				(152) Matte Antique Nickel	
(HD) Half Dummy				(112) Venetian Bronze	\$54.50
				(260) Polished Chrome	
				(141) Polished Nickel	
(EN) Entry		(R) Right Hand* (L) Left Hand*	(TRR) Traditional Round Rose (TAR) Traditional Arch Rose (TSR) Traditional Square Rose	(003) Polished Brass	\$174.00
(PS) Passage				(049) Matte Brass & Black	\$109.00
(PV) Privacy				(150) Satin Nickel	
(FD) Full Dummy				(152) Matte Antique Nickel	
(HD) Half Dummy				(112) Venetian Bronze	\$54.50
				(260) Polished Chrome	
				(141) Polished Nickel	

*Handing required for Half Dummy function and split style or split finish orders.
Other roses available, depending on finish.
Entry knobs and levers available with C-Keyway pin and tumbler cylinder only.





HOW TO ORDER: FUNCTION.STYLE.ROSE.FINISH



TUB.CRR

SQU.CSR

Function	Style	Handing*	Rose	Finish	List Price
(EN) Entry					\$174.00
(PS) Passage (PV) Privacy (FD) Full Dummy	(TUB) Tube 	(R) Right Hand (L) Left Hand	(CRR) Contemporary Round Rose (CSR) Contemporary Square Rose	(150) Satin Nickel (112) Venetian Bronze (260) Polished Chrome (141) Polished Nickel	\$109.00
(HD) Half Dummy					\$54.50
(EN) Entry					\$174.00
(PS) Passage (PV) Privacy (FD) Full Dummy	(SQU) Square 	(R) Right Hand (L) Left Hand	(CRR) Contemporary Round Rose (CSR) Contemporary Square Rose	(150) Satin Nickel (112) Venetian Bronze (260) Polished Chrome (141) Polished Nickel	\$109.00
(HD) Half Dummy					\$54.50

Contemporary Rose Options



*Handing not required for TUB and SQU styles.
Other rose styles available, depending on finish.
Entry knobs and levers available with C-Keyway pin and tumbler cylinder only.

HOW TO ORDER: FUNCTION.STYLE.HANDING.ROSE.FINISH



RUSTIC LEVERS



ARC.RAR



TAP.RSR

Function	Style	Handing*	Rose	Finish	List Price
(EN) Entry					\$189.00
(PS) Passage (PV) Privacy (FD) Full Dummy	(ARC) Arch 	(R) Right Hand (L) Left Hand	(RAR) Rustic Arch Rose (RSR) Rustic Square Rose	(481) Dark Bronze (492) White Bronze	\$139.00
(HD) Half Dummy					\$69.50
(EN) Entry					\$189.00
(PS) Passage (PV) Privacy (FD) Full Dummy	(TAP) Taper 	(R) Right Hand (L) Left Hand	(RAR) Rustic Arch Rose (RSR) Rustic Square Rose	(481) Dark Bronze (492) White Bronze	\$139.00
(HD) Half Dummy					\$69.50

*Handing is only required for ARC Half Dummy function and split style or split finish orders.

Rustic Rose Options



HOW TO ORDER: FUNCTION.STYLE.HANDING.ROSE.FINISH



Seattle Handleset, Contemporary Knocker and Rectangular Bell Button in Polished Chrome finish.

Item	Part Number	List Price	Specifications	Dimensions
------	-------------	------------	----------------	------------

DOOR ACCESSORIES

BR7001

S Knocker



- 9BR7001-001** Venetian Bronze 112
- 9BR7001-002** Satin Nickel 150
- 9BR7001-003** Polished Chrome 260
- 9BR7001-004** Polished Brass 003
- 9BR7001-005** Matte Antique Nickel 152
- 9BR7001-006** Matte Brass & Black 049
- 9BR7001-009** Polished Nickel 141

\$52.00

- Solid brass construction
- Available as a complete set with mounting hardware, installation instructions and drill template
- Mounted with through-holes and fits 1-3/4" doors
- Uses 10-24 thru-bolts

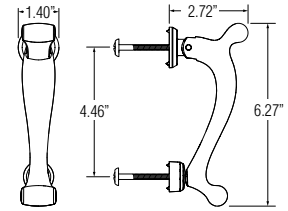

BR7002

Contemporary Knocker



- 9BR7002-001** Venetian Bronze 112
- 9BR7002-002** Satin Nickel 150
- 9BR7002-003** Polished Chrome 260
- 9BR7002-009** Polished Nickel 141

\$52.00

- Solid brass construction
- Available as a complete set with mounting hardware, installation instructions and drill template
- Mounted with through-holes and fits 1-3/4" doors
- Uses 10-24 thru-bolts

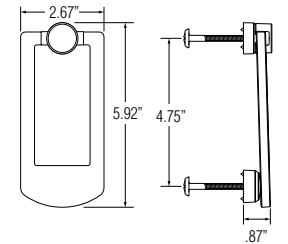

BR7003

Ring Knocker



- 9BR7003-001** Venetian Bronze 112
- 9BR7003-002** Satin Nickel 150
- 9BR7003-003** Polished Chrome 260
- 9BR7003-004** Polished Brass 003
- 9BR7003-005** Matte Antique Nickel 152
- 9BR7003-006** Matte Brass & Black 049
- 9BR7003-007** Dark Bronze 481
- 9BR7003-008** White Bronze 492
- 9BR7003-009** Polished Nickel 141

\$52.00

- Solid brass construction
- Available as a complete set with mounting hardware, installation instructions and drill template
- Mounted with through-holes and fits 1-3/4" doors
- Uses 10-24 thru-bolts

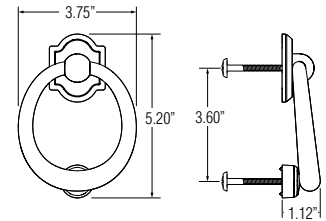

BR7015

Rectangular Bell Button



- 9BR7015-001** Venetian Bronze 112
- 9BR7015-002** Satin Nickel 150
- 9BR7015-003** Polished Chrome 260
- 9BR7015-004** Polished Brass 003
- 9BR7015-005** Matte Antique Nickel 152
- 9BR7015-006** Matte Brass & Black 049

\$32.00

- Brass construction with concealed fasteners
- Illuminated button for easy detection at night
- Recommended for use with up to 24 volt transformers
- Available as a complete set with mounting hardware

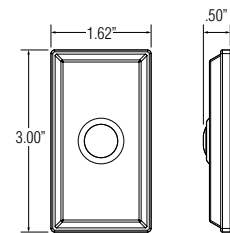

BR7016

Oval Bell Button



- 9BR7016-001** Venetian Bronze 112
- 9BR7016-002** Satin Nickel 150
- 9BR7016-003** Polished Chrome 260
- 9BR7016-004** Polished Brass 003
- 9BR7016-005** Matte Antique Nickel 152
- 9BR7016-006** Matte Brass & Black 049

\$32.00

- Brass construction with concealed fasteners
- Illuminated button for easy detection at night
- Recommended for use with up to 24 volt transformers
- Available as a complete set with mounting hardware

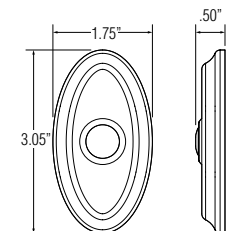

Item	Part Number	List Price	Specifications	Dimensions
------	-------------	------------	----------------	------------

DOOR ACCESSORIES

BR7017

Arch Bell Button



- 9BR7017-001** Venetian Bronze 112
- 9BR7017-002** Satin Nickel 150
- 9BR7017-003** Polished Chrome 260
- 9BR7017-004** Polished Brass 003
- 9BR7017-005** Matte Antique Nickel 152
- 9BR7017-006** Matte Brass & Black 049
- 9BR7017-007** Dark Bronze 481
- 9BR7017-008** White Bronze 492

\$32.00

- Brass construction with concealed fasteners
- Illuminated button for easy detection at night
- Recommended for use with up to 24 volt transformers
- Available as a complete set with mounting hardware

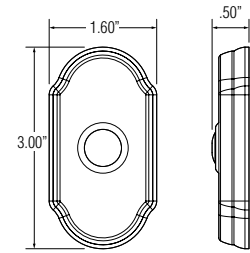

BR7004

Observascope



- 9BR7004-001** Venetian Bronze 112
- 9BR7004-002** Satin Nickel 150
- 9BR7004-003** Polished Chrome 260
- 9BR7004-004** Polished Brass 003

\$17.00

- Brass construction
- Provides one-way 170 degree angle visitor identification before entry
- Adjusts for use on 1.38" to 2.16" thick doors
- Bore hole diameter: 9/16"
- UL certified

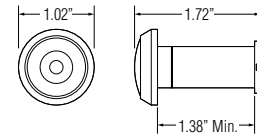

BR7012

Edge Pull



- 9BR7012-001** Venetian Bronze 112
- 9BR7012-002** Satin Nickel 150
- 9BR7012-003** Polished Chrome 260
- 9BR7012-004** Polished Brass 003
- 9BR7012-005** Matte Antique Nickel 152
- 9BR7012-006** Matte Brass & Black 049

\$15.00

- Brass construction
- Ideal for use on 1" or thicker doors
- Curved finger pull provides easy installation and use
- 1.32" pull projection

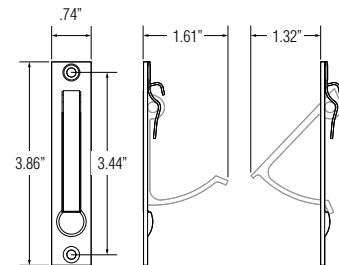

BR7018

Ball Catch



- 9BR7018-001** Venetian Bronze 112
- 9BR7018-002** Satin Nickel 150
- 9BR7018-003** Polished Chrome 260
- 9BR7018-004** Polished Brass 003
- 9BR7018-005** Matte Antique Nickel 152
- 9BR7018-006** Matte Brass & Black 049

\$18.50

- For use on louvered, bi-folding, accordion, closet and light to medium service doors
- Ball adjusts for door gap and latch tension
- Brass construction with steel ball
- Available as a complete set with mounting hardware

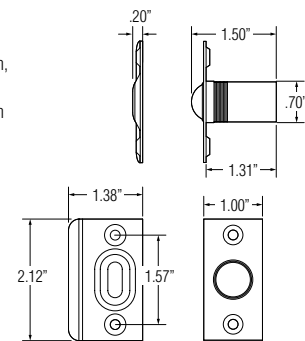

BR7020

Flush Bolt



- 9BR7020-001** Venetian Bronze 112
- 9BR7020-002** Satin Nickel 150
- 9BR7020-003** Polished Chrome 260
- 9BR7020-004** Polished Brass 003
- 9BR7020-005** Matte Antique Nickel 152
- 9BR7020-006** Matte Brass & Black 049

\$14.50

- Solid brass construction
- Features .94" extension bolt throw
- Smooth working action for easy operation
- Ideal for securing the inactive leaf of double doors
- Available as a complete set with strike, mounting hardware and installation instructions

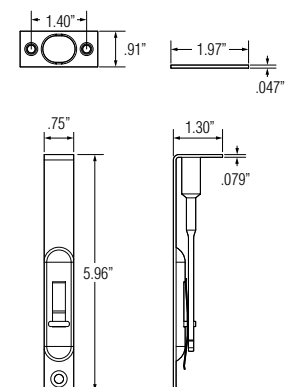

DOOR ACCESSORIES

Item	Part Number	List Price	Specifications	Dimensions
BR7021 Surface Bolt 6"	9BR7021-001 Venetian Bronze 112	\$26.00	<ul style="list-style-type: none"> • Solid brass construction • Ideal for securing doors, casement windows, cabinets and drawers • Furnished with both universal and mortise strikes • Solid brass mounting screws are concealed • Features .69" extension bolt throw and .67" knob projection from door 	
	9BR7021-002 Satin Nickel 150			
	9BR7021-003 Polished Chrome 260			
	9BR7021-004 Polished Brass 003			
	9BR7021-005 Matte Antique Nickel 152			
	9BR7021-006 Matte Brass & Black 049			
BR7022 Surface Bolt 4"	9BR7022-001 Venetian Bronze 112	\$23.00	<ul style="list-style-type: none"> • Solid brass mounting screws are concealed • Features .69" extension bolt throw and .67" knob projection from door 	
	9BR7022-002 Satin Nickel 150			
	9BR7022-003 Polished Chrome 260			
	9BR7022-004 Polished Brass 003			
	9BR7022-005 Matte Antique Nickel 152			
	9BR7022-006 Matte Brass & Black 049			

	A	B
Surface Bolt 6"	6"	5.25"
Surface Bolt 4"	4"	3.27"

WINDOW HARDWARE







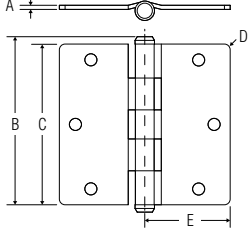

BR7013 Flush Pull	9BR7013-001 Venetian Bronze 112	\$17.00	<ul style="list-style-type: none"> • Brass construction • For use on large or heavy sliding doors and panels • Available as a complete set with mounting hardware and installation instructions 	
	9BR7013-002 Satin Nickel 150			
	9BR7013-003 Polished Chrome 260			
	9BR7013-004 Polished Brass 003			
	9BR7013-005 Matte Antique Nickel 152			
	9BR7013-006 Matte Brass & Black 049			

BR7014 Sash Lock	9BR7014-001 Venetian Bronze 112	\$18.00	<ul style="list-style-type: none"> • Solid brass construction • Secures and helps prevent air movement around double hung windows • Available as a complete set with mounting hardware 	
	9BR7014-002 Satin Nickel 150			
	9BR7014-003 Polished Chrome 260			
	9BR7014-004 Polished Brass 003			
	9BR7014-005 Matte Antique Nickel 152			
	9BR7014-006 Matte Brass & Black 049			

BR7019 Sash Lift	9BR7019-001 Venetian Bronze 112	\$16.00	<ul style="list-style-type: none"> • Solid brass construction • Ideal for use on double hung windows • Can also function as a door, cabinet or drawer pull • Projection: .97" • Includes mounting hardware 	
	9BR7019-002 Satin Nickel 150			
	9BR7019-003 Polished Chrome 260			
	9BR7019-004 Polished Brass 003			
	9BR7019-005 Matte Antique Nickel 152			
	9BR7019-006 Matte Brass & Black 049			

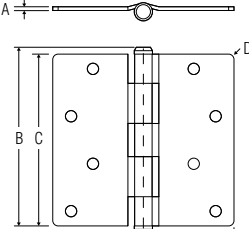
Item	Part Number	List Price	Specifications	Dimensions
DOOR STOPS				
BR7005 Rigid Door Stop 3" 	9BR7005-001 Venetian Bronze 112	\$12.00	<ul style="list-style-type: none"> • Brass construction • Heavy design helps prevent damage to walls • Pre-installed stud and slotted tip for easy installation 	
	9BR7005-002 Satin Nickel 150			
	9BR7005-003 Polished Chrome 260			
	9BR7005-004 Polished Brass 003			
	9BR7005-005 Matte Antique Nickel 152			
	9BR7005-006 Matte Brass & Black 049			
BR7006 Wall Bumper 1" (Convex) 	9BR7006-001 Venetian Bronze 112	\$13.00	<ul style="list-style-type: none"> • Brass collar • Convex surface with durable rubber bumper for long operating life • Includes mounting hardware and installation instructions 	
	9BR7006-002 Satin Nickel 150			
	9BR7006-003 Polished Chrome 260			
	9BR7006-004 Polished Brass 003			
	9BR7006-005 Matte Antique Nickel 152			
	9BR7006-006 Matte Brass & Black 049			
BR7029 Wall Bumper 2.4" (Convex) 	9BR7029-001 Venetian Bronze 112	\$13.00	<ul style="list-style-type: none"> • Brass collar • Convex surface with durable rubber bumper for long operating life • Includes mounting hardware and installation instructions 	
	9BR7029-002 Satin Nickel 150			
	9BR7029-003 Polished Chrome 260			
	9BR7029-004 Polished Brass 003			
	9BR7029-005 Matte Antique Nickel 152			
	9BR7029-006 Matte Brass & Black 049			
BR7007 Wall Bumper 2.4" (Concave) 	9BR7007-001 Venetian Bronze 112	\$13.00	<ul style="list-style-type: none"> • Brass collar • Concave surface with durable rubber bumper for long operating life • Includes mounting hardware and installation instructions 	
	9BR7007-002 Satin Nickel 150			
	9BR7007-003 Polished Chrome 260			
	9BR7007-004 Polished Brass 003			
	9BR7007-005 Matte Antique Nickel 152			
	9BR7007-006 Matte Brass & Black 049			
BR7008 Floor Bumper .38" 	9BR7008-001 Venetian Bronze 112	\$13.50	<ul style="list-style-type: none"> • Solid brass shell • Stops door and prevents damage to wall and doors • Positive stopping action provided by non-marring bumper 	
	9BR7008-002 Satin Nickel 150			
	9BR7008-003 Polished Chrome 260			
	9BR7008-004 Polished Brass 003			
	9BR7008-005 Matte Antique Nickel 152			
	9BR7008-006 Matte Brass & Black 049			
BR7009 Floor Bumper .13" 	9BR7009-001 Venetian Bronze 112	\$13.50	<ul style="list-style-type: none"> • Designed for undercut doors or doors without threshold • Includes installation instructions and plastic anchor for concrete floor installation 	
	9BR7009-002 Satin Nickel 150			
	9BR7009-003 Polished Chrome 260			
	9BR7009-004 Polished Brass 003			
	9BR7009-005 Matte Antique Nickel 152			
	9BR7009-006 Matte Brass & Black 049			

	A	B	C
Floor Bumper .38"	1.77"	1.24"	1.12"
Floor Bumper .13"	1.77"	1.09"	1.12"

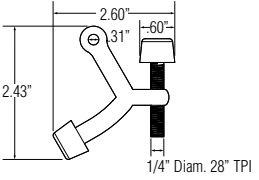
Item	Part Number	List Price	Specifications	Dimensions																						
HINGES																										
BR7023 3.5" 1/4" Radius 	9BR7023-001 Venetian Bronze 112 9BR7023-002 Satin Nickel 150 9BR7023-003 Polished Chrome 260 9BR7023-004 Polished Brass 003 9BR7023-005 Matte Antique Nickel 152 9BR7023-006 Matte Brass & Black 049	\$15.50	<ul style="list-style-type: none"> • Solid brass construction designed for residential door applications • Five knuckle, friction fit design with brass headed pin • Non-rising pin with hole in bottom tip for easy removal • Available as a complete set with mounting hardware • Ordered and packed one (1) hinge per box • Hinges ship dry to prevent chemical contamination on doors or wood jambs before finishing 	<div style="border: 1px solid black; padding: 5px; margin-bottom: 10px;"> Care & Maintenance <ul style="list-style-type: none"> • Recommended to lubricate hinge pin with heavy bearing grease • To lubricate, extract pin and wipe or dip with grease. Reinsert pin. Grease will work into load bearing surface. Wipe excess grease and dirt from hinge </div>  <table border="1" style="width: 100%; text-align: center;"> <thead> <tr> <th>A</th> <th>B</th> <th>C</th> <th>D</th> <th>E</th> </tr> </thead> <tbody> <tr> <td>.08"</td> <td>3.82"</td> <td>3.5"</td> <td>.25"</td> <td>1.86"</td> </tr> <tr> <td>.08"</td> <td>3.82"</td> <td>3.5"</td> <td>.625"</td> <td>1.86"</td> </tr> <tr> <td>.08"</td> <td>3.83"</td> <td>3.5"</td> <td>N/A</td> <td>1.86"</td> </tr> </tbody> </table>	A	B	C	D	E	.08"	3.82"	3.5"	.25"	1.86"	.08"	3.82"	3.5"	.625"	1.86"	.08"	3.83"	3.5"	N/A	1.86"		
	A	B			C	D	E																			
	.08"	3.82"			3.5"	.25"	1.86"																			
	.08"	3.82"			3.5"	.625"	1.86"																			
	.08"	3.83"			3.5"	N/A	1.86"																			
	BR7024 3.5" 5/8" Radius 	9BR7024-001 Venetian Bronze 112 9BR7024-002 Satin Nickel 150 9BR7024-003 Polished Chrome 260 9BR7024-004 Polished Brass 003 9BR7024-005 Matte Antique Nickel 152 9BR7024-006 Matte Brass & Black 049			\$15.50																					
BR7025 3.5" Square 		9BR7025-001 Venetian Bronze 112 9BR7025-002 Satin Nickel 150 9BR7025-003 Polished Chrome 260 9BR7025-004 Polished Brass 003 9BR7025-005 Matte Antique Nickel 152 9BR7025-006 Matte Brass & Black 049	\$15.50	3.5" 1/4" Radius 3.5" 5/8" Radius 3.5" Square																						
		BR7026 4" 1/4" Radius 	9BR7026-001 Venetian Bronze 112 9BR7026-002 Satin Nickel 150 9BR7026-003 Polished Chrome 260 9BR7026-004 Polished Brass 003 9BR7026-005 Matte Antique Nickel 152 9BR7026-006 Matte Brass & Black 049	\$17.00	<ul style="list-style-type: none"> • Solid brass construction designed for residential door applications • Five knuckle, friction fit design with brass headed pin • Non-rising pin with hole in bottom tip for easy removal • Available as a complete set with mounting hardware • Ordered and packed one (1) hinge per box • Hinges ship dry to prevent chemical contamination on doors or wood jambs before finishing 	<div style="border: 1px solid black; padding: 5px; margin-bottom: 10px;"> Care & Maintenance <ul style="list-style-type: none"> • Recommended to lubricate hinge pin with heavy bearing grease • To lubricate, extract pin and wipe or dip with grease. Reinsert pin. Grease will work into load bearing surface. Wipe excess grease and dirt from hinge </div>  <table border="1" style="width: 100%; text-align: center;"> <thead> <tr> <th>A</th> <th>B</th> <th>C</th> <th>D</th> <th>E</th> </tr> </thead> <tbody> <tr> <td>.09"</td> <td>4.32"</td> <td>4"</td> <td>.25"</td> <td>2.11"</td> </tr> <tr> <td>.09"</td> <td>4.32"</td> <td>4"</td> <td>.625"</td> <td>2.11"</td> </tr> <tr> <td>.09"</td> <td>4.32"</td> <td>4"</td> <td>N/A</td> <td>2.11"</td> </tr> </tbody> </table>	A	B	C	D	E	.09"	4.32"	4"	.25"	2.11"	.09"	4.32"	4"	.625"	2.11"	.09"	4.32"	4"	N/A	2.11"
			A	B			C	D	E																	
			.09"	4.32"			4"	.25"	2.11"																	
			.09"	4.32"			4"	.625"	2.11"																	
	.09"		4.32"	4"			N/A	2.11"																		
BR7027 4" 5/8" Radius 	9BR7027-001 Venetian Bronze 112 9BR7027-002 Satin Nickel 150 9BR7027-003 Polished Chrome 260 9BR7027-004 Polished Brass 003 9BR7027-005 Matte Antique Nickel 152 9BR7027-006 Matte Brass & Black 049		\$17.00																							
	BR7028 4" Square 	9BR7028-001 Venetian Bronze 112 9BR7028-002 Satin Nickel 150 9BR7028-003 Polished Chrome 260 9BR7028-004 Polished Brass 003 9BR7028-005 Matte Antique Nickel 152 9BR7028-006 Matte Brass & Black 049	\$17.00	4" 1/4" Radius 4" 5/8" Radius 4" Square																						
		BR7011 Hinge Pin Door Stop 	9BR7011-001 Venetian Bronze 112 9BR7011-002 Satin Nickel 150 9BR7011-003 Polished Chrome 260 9BR7011-004 Polished Brass 003 9BR7011-005 Matte Antique Nickel 152 9BR7011-006 Matte Brass & Black 049	\$9.50	<ul style="list-style-type: none"> • Solid brass construction • Adjustable to stop door at any angle with rubber pad making contact with door • Hinge pin door stop can be used with Reserve hinges only. Not compatible with Baldwin Estate hinges. 																					

FUNCTIONS

Handlesets	Deadbolts	Knobs/Levers
Single Cylinder (SC) BR180	Single Cylinder (SC) BR380	Passage (PS) BR352
		Privacy (PV) BR353
Double Cylinder (DC) BR181	Double Cylinder (DC) BR385	Keyed Entry (EN) BR354
		Full Dummy (FD) BR35 Full Bore Required
Full Dummy (FD) BR182	Patio (PT) BR390	Half Dummy (HD) BR350 Surface Mounted

HANDING

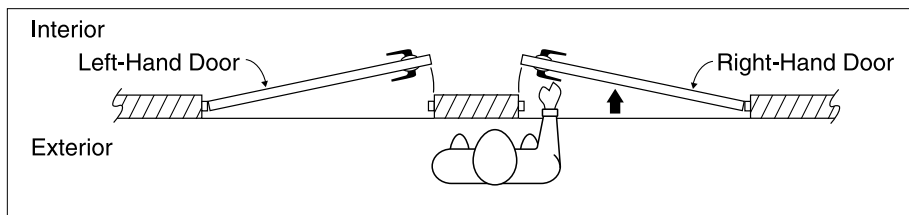

- Handing required for half-dummy levers, handlesets with lever interior, split lever styles (including knob with lever), and split lever finish orders.
- To determine the handing of a door:
 - Facing the door from the EXTERIOR, locate the location of the hinges.
 - If the hinges are located on the left side of the door, the door is left handed (L)
 - If the hinges are located on the right side of the door, the door is right handed (R)

DOOR THICKNESS

	1 3/8" to 1 3/4"	1 3/4" to 2"	2" to 2 1/2"
Handlesets	Optional Napa and Westcliff styles, single cylinder and double cylinder only	Standard*	Optional
Deadbolts	Optional Traditional and Contemporary styles, single cylinder and double cylinder only	Standard*	Optional
Patio Deadbolts	Standard		Optional
Knobs	Standard		Optional
Levers	Standard		Optional

*For double cylinder (DC) function, customers will need to replace a torque blade if the application is on a 2" thick door.

ORDER OPTIONS

LATCH OPTIONS

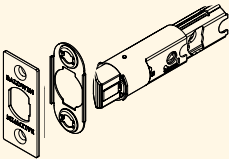
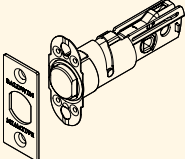
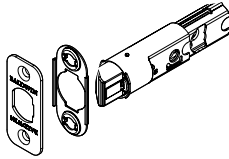
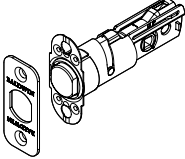
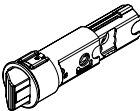
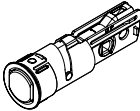
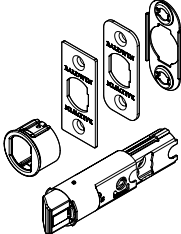
Product Code	Description	List Price Adder	Knobs & Levers	Deadbolts
(SL)	Adjustable latch with Square-Corner Front DEFAULT	No Charge		
(SLUL)	Adjustable latch with Square-Corner Front 20-minute Certified UL	\$5.00 List		
(RL)	Adjustable latch with Round-Corner Front	No Charge		
(RLUL)	Adjustable latch with Round-Corner Front 20-minute Certified UL	\$5.00 List		
(DL)	Adjustable latch with Drive-In Collar	No Charge		
(DIUL)	Adjustable latch with Drive-In Collar 20-minute Certified UL	\$5.00 List		
(6L)	Latch with kit including collar, back plate, and round and square fronts	No Charge		

All latches are adjustable to accommodate 2-3/8" or 2-3/4" backsets.

STRIKE OPTIONS

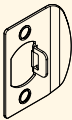
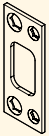
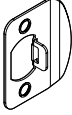
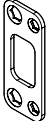
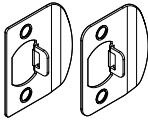
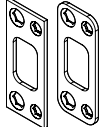
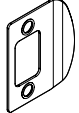
Product Code	Description	List Price Adder	Knobs & Levers	Deadbolts
(SS)	Square Corner Strike DEFAULT	No Charge		
(RS)	Round Corner Strike	No Charge		
(DS)	Dual Strike kit that includes both Square Corner & Round Corner Strikes	No Charge		
(FS)	Full Lip Deadbolt Strike	No Charge	N/A	

Extended Lip Square Corner Strike will ship with all thick knob/lever door options (ES)

Highlighted box indicates product will ship with default option.

CYLINDER OPTIONS

Product Code	Description	Handlesets	Deadbolts	Knobs & Levers
C-Keyway (CKY)	Baldwin 5-pin pin & tumbler C-Keyway DEFAULT	✓	✓	✓
SmartKey (SMT)	5-pin SmartKey Re-key Technology with KW1 Keyway	✓	✓	N/A

KEYING OPTIONS

Keying	Definition	CKY	SMT	Additional Charge	Notes	Ordering Example
Keyed Different (KD)	Each lock is individually keyed to a different key cut. DEFAULT	✓	✓	No Charge	<ul style="list-style-type: none"> Default keying option for all cylinder types KD orders will receive 1 set of 2 keys cut the same (additional keys can be ordered through the service parts program) 	KD is the default keying option for all cylinder types and does not need to be specified in the order.
Keyed Alike (KA)	All lock are keyed to the same key cut.	✓	✓	No Charge	<ul style="list-style-type: none"> Only available within a given cylinder type; CKY can be keyed to another CKY but can not be keyed to SMT Reserve product can not be ordered keyed alike to other non-Reserve Baldwin products Keyed alike orders will receive 1 set of 4 keys cut the same for the entire series 	<p>All locks on the same line item are keyed alike. Example. 2 SC.TRD.150.K2</p> <p>1. Quantity 2. The line item represents the deadbolt style and finish. 3. K2 represents that the two locks are keyed alike.</p>
With (WITH)	All lock across multiple lines are keyed to the same key cut.	✓	✓	No Charge	<ul style="list-style-type: none"> Only available within a given cylinder type; CKY can be keyed to another CKY but can not be keyed to SMT Reserve product can not be ordered keyed alike to other non-Reserve Baldwin products Keyed alike orders will receive 1 set of 4 keys cut the same for the entire series 	<p>Keys multiple line items of locks together Example. SC.TRD.150.WITH EN.TRA.TRR.150.K2</p> <p>1. Represents end of bundle and total quantity of locks keyed together. 2. Item to be keyed</p>
Key Code (KC)	Customer selects the specific key cut that they would like the cylinder keyed to be keyed to.	✓	✓	No Charge	<ul style="list-style-type: none"> Customer must specify the 5-digit code they would like the cylinders to be keyed to. CKY cuts will range between 0-9 and SMT cuts will range between 1-6 KC keys will not have the key code stamped on the back of the key 	<p>Keys lock to a specific key-cut Example. SC.TRD.150.35829</p> <p>1. Represents customer specified key cut.</p>
Construction Key (CK)	Allows new homes to be keyed to a builder's key during construction only. Once the homeowner uses their key, the builder key is rendered inoperable.	✓		\$5.00	<ul style="list-style-type: none"> Customer must specify builder key code and if home owner's key needs to be keyed alike to other products on order Reserve product can not be ordered keyed alike to other non-Reserve Baldwin products 	<p>Allows a builder to operate a lock during construction. Once the homeowner uses their key, the builder key is rendered inoperable. Example. SC.TRD.150.CK 35829</p> <p>1. CK indicates the cylinder should be Construction Keyed. 2. Represents the builder key code – must be specified when ordering.</p>
Master Key (MK)	Allows multiple keys to operate a single lock. Often used in multi-family applications for owners and tenants.	✓		\$5.00	<ul style="list-style-type: none"> Customer must specify master key code and if home owner's key needs to be keyed alike to other products on order Reserve product can not be ordered keyed alike to other non-Reserve Baldwin products 	<p>Allows maintenance access. Example. SC.TRD.150.MK 59579</p> <p>1. MK indicates the cylinder should be Master Keyed. 2. Represents the Master Key Code – must be specified when ordering.</p>

Please note that Reserve product can not be ordered keyed alike to other Baldwin Prestige Series™ or Estate product. For service parts, see pages 34-39.

DIMENSIONS & SPECIFICATIONS – HANDLESETS

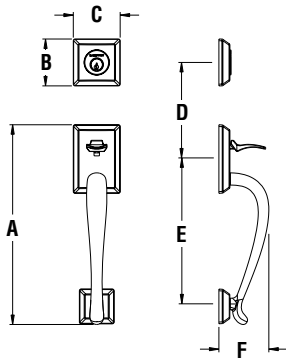

SECTIONAL					
	NAP	COL	WES	LAJ	ADI
A	11-1/2"	12"	12-1/16"	12-15/32"	12-1/16"
B	2-11/16"	3-15/16"	3-7/16"	3-11/32"	3-7/8"
C	2-11/16"	2-11/16"	2-11/16"	2-11/16"	2-11/16"
D	Adjustable	Adjustable	Adjustable	Adjustable	Adjustable
E	8-13/32"	8-13/32"	8-13/32"	8-13/32"	8-13/32"
F	2-8/9"	2-8/9"	3-1/16"	2-13/32"	3-1/8"

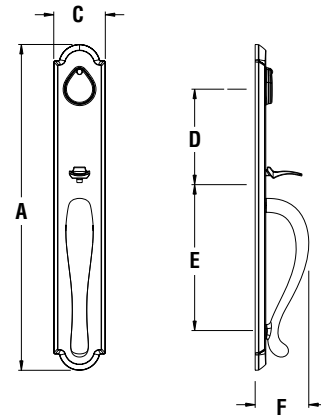

FULL ESCUTCHEON			
	SAN	ELK	LON
A	17-1/2"	18-3/4"	18-1/2"
B	N/A	N/A	N/A
C	2-11/16"	2-15/16"	2-15/16"
D	5-1/2"	5-1/2"	5-1/2"
E	8-13/32"	8-13/32"	8-13/32"
F	2-13/32"	3-1/16"	3-1/8"

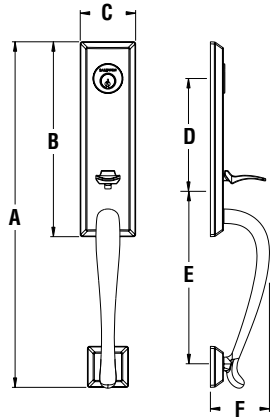

3/4 ESCUTCHEON				
	DEL	CHE	NEW	ELI
A	16-13/16"	18-1/4"	17-5/8"	18-11/16"
B	9-1/2"	10-13/16"	10-5/16"	10-5/16"
C	2-11/16"	3-1/8"	2-11/16"	2-11/16"
D	5-1/2"	5-1/2"	5-1/2"	5-1/2"
E	8-13/32"	8-13/32"	8-13/32"	8-13/32"
F	2-8/9"	2-8/9"	3-1/16"	3-5/16"

3/4 ESCUTCHEON			
	MIA	SEA	KOD
A	18-1/16"	17-1/2"	18-1/2"
B	9-7/8"	9-1/2"	10-9/16"
C	2-11/16"	2-11/16"	2-15/16"
D	5-1/2"	5-1/2"	5-1/2"
E	8-13/32"	8-13/32"	8-13/32"
F	3"	2-7/16"	3-1/16"

HANDLESET SPECIFICATIONS	
Door Preparation	2-1/8" Cross Bore for both deadbolt and grip. 1" edge bore for both grip latch and deadbolt latch. 5-1/2" center to center tubular bore.
Door Thickness	1-3/4" to 2" standard. Up to 2-1/2" doors optional through thick door options or service part kit. Napa and Westcliff styles only; 1-3/8" to 1-3/4" thin door option available through options.
Cylinder	Baldwin C-Keyway standard. SmartKey® Re-key Technology optional.
Backset	Adjustable 2-3/8" or 2-3/4"
Front & Latch	Square Corner Adjustable (SL) standard. Round Corner (RL), Drive-In (DL), or 6 Way Adjustable (6L) optional.
Strike	Square Corner (SS) standard. Round Corner (RS), or Dual Strike (DS) optional. Extended Lip strike shipped with all thick door locks (ES).
Latch Bolt	Deadbolt features 1" throw Brass bolt latch. Grip offers 1/2" passage/privacy function bolt.
Handing	Handing only required when ordering lever interior style.
ANSI/BHMA	Deadbolt tested to exceed ANSI/BHMA Grade 2 security.
ADA	N/A
UL	20-minute certified UL option available.

DIMENSIONS & SPECIFICATIONS – DEADBOLTS

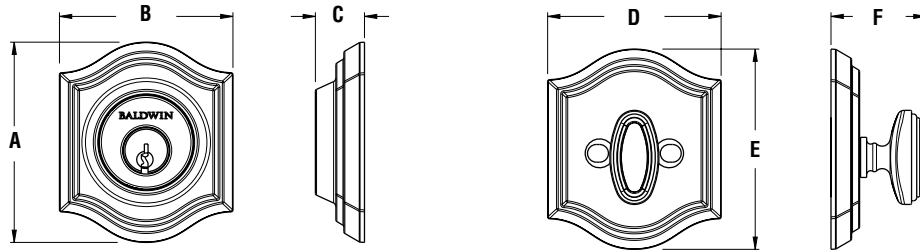

DEADBOLT							
	TRD	TSD	TAD	CRD	CSD	RAD	RSD
A	Ø 2-3/5"	2-3/5"	3-1/16"	Ø 2-5/8"	2-9/16"	3-5/8"	3-1/8"
B	N/A	2-3/5"	2-11/16"	N/A	2-9/16"	2-11/16"	2-9/16"
C	3/4"	3/4"	3/4"	3/4"	3/4"	1-1/16"	1-1/16"
D	Ø 2-5/8"	2-5/8"	2-11/16"	Ø 2-5/8"	2-5/8"	2-11/16"	2-5/8"
E	N/A	2-5/8"	3-1/16"	N/A	2-5/8"	3-7/16"	2-5/8"
F (SC)	1-7/16"	1-7/16"	1-7/16"	1-7/16"	1-7/16"	1-7/16"	1-7/16"
F (DC)	3/4"	3/4"	3/4"	3/4"	3/4"	1-1/16"	1-1/16"

DEADBOLT SPECIFICATIONS

Door Preparation	Deadbolt: 2-1/8" Cross Bore. 1" edge bore for latch. Patio: 1-7/8" counterbore. 1" edge bore for latch.
Door Thickness	1-3/4" to 2" standard. Up to 2-1/2" doors optional through thick door option or service part kit. Traditional & Contemporary styles: 1-3/8" to 1-3/4" doors available through thin door option or service part kit. Thin door option not available with rustic deadbolt styles.
Cylinder	Baldwin C-Key standard. SmartKey® Re-Key Technology optional.
Backset	Adjustable 2-3/8" or 2-3/4"
Front & Latch	Square Corner Adjustable (SL) standard. Round Corner (RL), Drive In (DL), or 6 Way Adjustable (6L) optional.
Strike	Square Corner (SS) standard. Round Corner (RS), Dual Strike (DS), or Full Lip Strike (FS) optional.
Latch Bolt	Deadbolt features 1" throw Brass bolt latch.
Handing	Handing not required.
ANSI/BHMA	Tested to exceed ANSI/BHMA Grade 2 security.
ADA	N/A
UL	20-minute certified UL option available.

DIMENSIONS & SPECIFICATIONS – KNOBS

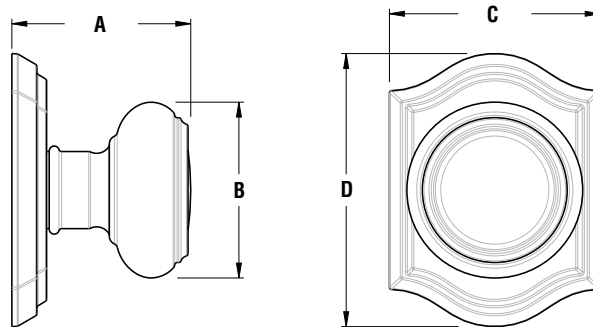

KNOBS						
	CRY	ELI	ROU	TRA	CON	RUS
A	2-29/32"	2-11/32"	2-7/32"	2-1/4"	2-5/32"	2-7/32"
A (Keyed)	N/A	2-3/16"	2-3/16"	2-3/16"	2-3/16"	2-3/16"
B	2-3/16"	2-7/16"	Ø 2-3/16"	2-7/32"	2-11/32"	2-11/32"

ROSES							
	TRR	TAR	TSR	CRR	CSR	RAR	RSR
C	2-9/16"	2-21/32"	2-19/32"	2-9/16"	2-9/16"	2-11/16"	2-5/8"
D	2-9/16"	3-7/16"	2-19/32"	2-9/16"	2-9/16"	4-1/2"	4"

KNOB SPECIFICATIONS

Door Preparation	2-1/8" Cross Bore. 1" edge bore for latch.
Installation Type	Entry, Privacy, Passage and Full Dummy: Full Bore required. Half Dummy: Surface mounted.
Door Thickness	1-3/8" to 2" standard. 2" to 2-1/2" doors optional through thick door option or service part kit.
Cylinder	Baldwin 5-pin C-Keyway.
Backset	Adjustable 2-3/8" or 2-3/4"
Front & Latch	Square Corner Adjustable (SL) standard. Round Corner (RL), Drive In (DL), or 6 Way Adjustable (6L) optional.
Strike	Square Corner (SS) standard. Round Corner (RS), or Dual Strike (DS) optional. Extended Lip strike shipped with all thick door locks (ES).
Latch Bolt	½" passage/privacy/entry function bolt.
Handing	Handing not required.
ANSI/BHMA	Tested to exceed ANSI/BHMA Grade 2 security.
ADA	N/A
UL	20-minute certified UL option available.

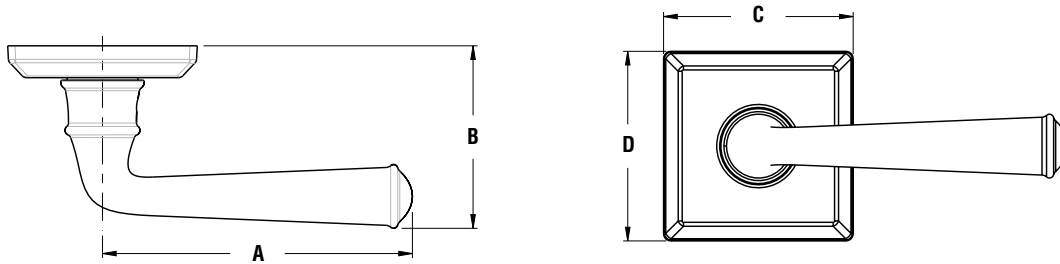

LEVERS							
	ARC	CUR	DEC	FED	SQU	TAP	TUB
A	4-1/2"	3-31/32"	4-1/4"	4-1/4"	4-1/4"	4-1/4"	4-1/4"
B	2-9/16"	2-17/32"	2-3/4"	2-1/2"	2-3/8"	2-7/16"	2-9/32"
B (Keyed)	2-3/8"	2-13/32"	2-9/16"	2-9/16"	2-3/16"	2-1/4"	2-3/16"

ROSES							
	TRR	TAR	TSR	CRR	CSR	RAR	RSR
C	2-9/16"	2-21/32"	2-19/32"	2-9/16"	2-9/16"	2-11/16"	2-5/8"
D	2-9/16"	3-7/16"	2-19/32"	2-9/16"	2-9/16"	4-1/2"	4"

LEVER SPECIFICATIONS	
Door Preparation	2-1/8" Cross Bore. 1" edge bore for latch.
Installation Type	Entry, Privacy, Passage and Full Dummy: Full Bore required. Half Dummy: Surface mounted.
Door Thickness	1-3/8" to 2" standard. 2" to 2-1/2" doors optional through thick door option or service part kit.
Cylinder	Baldwin 5-pin C-Keyway.
Backset	Adjustable 2-3/8" or 2-3/4"
Front & Latch	Square Corner Adjustable (SL) standard. Round Corner (RL), Drive In (DL), or 6 Way Adjustable (6L) optional.
Strike	Square Corner (SS) standard. Round Corner (RS), or Dual Strike (DS) optional. Extended Lip strike shipped with all thick door locks (ES).
Latch Bolt	1/2" passage/privacy/entry function bolt.
Handing	With exception to half dummy function, all levers are reversible for right or left hand doors.
ANSI/BHMA	Tested to exceed ANSI/BHMA Grade 2 security.
ADA	Passage (BR352) products meet ADA requirements.
UL	20-minute certified UL option available.

SERVICE PARTS – KEYS AND CYLINDERS

KEY BLANKS

Part No.	Item	Qty.	List Price
8BR0100-007	C-Keyway, Baldwin Bow	10	\$25.00
8BR0100-008	SmartKey, Baldwin Bow	10	\$25.00

CUT KEYS - RANDOM CUT

Part No.	Item	Qty.	List Price
8BR0100-001	C-Keyway, 2 Keys on a Ring	1 set	\$4.00
8BR0100-002	C-Keyway, 4 Keys on a Ring	1 set	\$8.00
8BR0100-004	SmartKey with Learn Tool, 2 Keys on a Ring	1 set	\$4.25
8BR0100-005	SmartKey with Learn Tool, 4 Keys on a Ring	1 set	\$8.50

CUT KEYS – KEY CODE *(Keys cut to specific cut)*

Part No.	Item	Qty.	List Price
8BR0100-003	C-Keyway, 2 Keys on a Ring	1 set	\$5.00
8BR0100-006	SmartKey with Learn Tool, 2 Keys on a Ring	1 set	\$5.25

CYLINDERS – SINGLE CYLINDER DEADBOLT *Includes Cylinder Assembly With Housing*

Core Part No.	Item	FINISHES									Qty.	List Price
		003	049	112	150	152	260	481	492	141		
8BR0201-xxx	C-Keyway, 2 Keys on a Ring	-001	-002	-003	-004	-005	-006	-007	-008	-009	1	\$17.25
8BR0206-xxx	C-Keyway, 4 Keys on a Ring	-001	-002	-003	-004	-005	-006	-007	-008	-009	1	\$21.25
8BR0211-xxx	C-Keyway, KC – Key Code 2 Keys	-001	-002	-003	-004	-005	-006	-007	-008	-009	1	\$18.25
8BR0204-xxx	SmartKey 2 Keys on a Ring	-001	-002	-003	-004	-005	-006	-007	-008	-009	1	\$17.50
8BR0209-xxx	SmartKey 4 Keys on a Ring	-001	-002	-003	-004	-005	-006	-007	-008	-009	1	\$21.50
8BR0214-xxx	SmartKey KC – Key Code 2 Keys	-001	-002	-003	-004	-005	-006	-007	-008	-009	1	\$18.50

TO ORDER: COMBINE PART NO. AND FINISH SUFFIX EX: 8BR0201-XXX AND -001 = 8BR0201-001

CYLINDERS – DOUBLE CYLINDER DEADBOLT Includes Cylinder Assembly With Housing

Core Part No.	Item	FINISHES										Qty.	List Price
		003	049	112	150	152	260	481	492	141			
8BR0202-xxx	C-Keyway, 2 Keys on a Ring	-001	-002	-003	-004	-005	-006	-007	-008	-009	1	\$34.50	
8BR0207-xxx	C-Keyway, 4 Keys on a Ring	-001	-002	-003	-004	-005	-006	-007	-008	-009	1	\$39.00	
8BR0212-xxx	C-Keyway, KC – Key Code 2 Keys	-001	-002	-003	-004	-005	-006	-007	-008	-009	1	\$35.50	
8BR0205-xxx	SmartKey 2 Keys on a Ring	-001	-002	-003	-004	-005	-006	-007	-008	-009	1	\$34.75	
8BR0210-xxx	SmartKey 4 Keys on a Ring	-001	-002	-003	-004	-005	-006	-007	-008	-009	1	\$38.75	
8BR0215-xxx	SmartKey KC – Key Code 2 Keys	-001	-002	-003	-004	-005	-006	-007	-008	-009	1	\$35.75	

CYLINDERS – KNOB AND LEVER Includes Cylinder Assembly With Housing

Core Part No.	Item	FINISHES			Qty.	List Price
		Gold	Silver	Bronze		
8BR0203-xxx	C-Keyway, 2 Keys on a Ring	-001	-002	-003	1	\$13.00
8BR0208-xxx	C-Keyway, 4 Keys on a Ring	-001	-002	-003	1	\$17.00
8BR0213-xxx	C-Keyway, KC – Key Code 2 Keys	-001	-002	-003	1	\$14.00

CYLINDER PLUGS

Core Part No.	Item	FINISHES			Qty.	List Price
		Gold	Silver	Bronze		
8BR0615-xxx	Deadbolt Cylinder Plug, C-Keyway	-001	-002	-003	1	\$3.50
8BR0616-xxx	Knob/Lever Cylinder Plug, C-Keyway	-001	-002	-003	1	\$3.50

BUILDING A SERVICE PART NUMBER

8BR0501-XXX



To create service part # combine core and function suffix.

Example: **8BR0501-001**

For Single Cylinder screwpack in polished brass (Standard door thickness).

TO ORDER: COMBINE PART NO. AND FINISH SUFFIX EX: 8BR0615-XXX AND -002 = 8BR0615-002

SERVICE PARTS – LATCHES & FRONTS

LATCHES

Part No./Core No.	Item	FINISHES										Qty.	List Price
		003	049	112	150	152	260	481	492	141			
8BR0301-001	Deadlatch, core latch for Entry (EN) lever/knob	N/A	N/A	N/A	N/A	N/A	N/A	N/A	N/A	N/A	N/A	1	\$9.50
8BR0302-001	Plainlatch, for Handleset (SC/DC) and Knob/Lever (PS/PV)	N/A	N/A	N/A	N/A	N/A	N/A	N/A	N/A	N/A	N/A	1	\$8.50
8BR0303-001	Deadbolt, core latch with backplate for Handleset (SC/DC) and deadbolt (SC / DC)	N/A	N/A	N/A	N/A	N/A	N/A	N/A	N/A	N/A	N/A	1	\$14.00
8BR0304-xxx	Deadlatch, 6L for Entry (EN) lever/knob	-001	-002	-003	-004	-005	-006	-007	-008	-009	1	\$18.50	
8BR0305-xxx	Plainlatch, 6L for Handleset (SC/DC) and Knob/Lever (PS/PV)	-001	-002	-003	-004	-005	-006	-007	-008	-009	1	\$17.50	
8BR0306-xxx	Deadbolt, 6L for Handleset (SC/DC) and deadbolt (SC/DC)	-001	-002	-003	-004	-005	-006	-007	-008	-009	1	\$23.00	
8BR0307-xxx	Deadlatch, SL UL for Entry (EN) lever/knob	-001	-002	-003	-004	-005	-006	-007	-008	-009	1	\$18.50	
8BR0308-xxx	Deadlatch, RL UL for Entry (EN) lever/knob	-001	-002	-003	-004	-005	-006	-007	-008	-009	1	\$18.50	
8BR0309-001	Deadlatch, DL UL for Entry (EN) lever/knob	N/A	N/A	N/A	N/A	N/A	N/A	N/A	N/A	N/A	1	\$18.50	
8BR0310-xxx	Plainlatch, SL UL for Handleset (SC/DC) and Knob/Lever (PS/PV)	-001	-002	-003	-004	-005	-006	-007	-008	-009	1	\$17.50	
8BR0311-xxx	Plainlatch, RL UL for Handleset (SC/DC) and Knob/Lever (PS/PV)	-001	-002	-003	-004	-005	-006	-007	-008	-009	1	\$17.50	
8BR0312-001	Plainlatch, DL UL for Handleset (SC/DC) and Knob/Lever (PS/PV)	N/A	N/A	N/A	N/A	N/A	N/A	N/A	N/A	N/A	1	\$17.50	
8BR0313-xxx	Deadbolt, SL UL for Handleset (SC/DC) and deadbolt (SC/DC)	-001	-002	-003	-004	-005	-006	-007	-008	-009	1	\$23.00	
8BR0314-xxx	Deadbolt, RL UL Deadbolt, SL UL for Handleset (SC/DC) and deadbolt (SC/DC)	-001	-002	-003	-004	-005	-006	-007	-008	-009	1	\$23.00	
8BR0315-001	Deadbolt, DL UL Deadbolt, SL UL for Handleset (SC/DC) and deadbolt (SC/DC)	N/A	N/A	N/A	N/A	N/A	N/A	N/A	N/A	N/A	1	\$23.00	
8BR0316-xxx	Deadbolt, SL Front with screws for Handleset (SC/DC) and deadbolt (SC/DC)	-001	-002	-003	-004	-005	-006	-007	-008	-009	1	\$4.50	
8BR0317-xxx	Deadbolt, RC Front with screws for Handleset (SC/DC) and deadbolt (SC/DC)	-001	-002	-003	-004	-005	-006	-007	-008	-009	1	\$4.50	
8BR0318-001	Deadbolt, DL Collar for Handleset (SC/DC) and deadbolt (SC/DC)	N/A	N/A	N/A	N/A	N/A	N/A	N/A	N/A	N/A	1	\$4.50	
8BR0320-xxx	Plainlatch, SL Front with screws for Handleset (SC/DC) and Knob/Lever (PS/PV)	-001	-002	-003	-004	-005	-006	-007	-008	-009	1	\$4.50	
8BR0321-xxx	Plainlatch, RC Front with screws for Handleset (SC/DC) and Knob/Lever (PS/PV)	-001	-002	-003	-004	-005	-006	-007	-008	-009	1	\$4.50	
8BR0322-001	Plainlatch, DL Collar for Handleset (SC/DC) and Knob/Lever (PS/PV)	N/A	N/A	N/A	N/A	N/A	N/A	N/A	N/A	N/A	1	\$4.50	
8BR0324-xxx	Deadlatch, SL Front with screws for Entry (EN) lever/knob	-001	-002	-003	-004	-005	-006	-007	-008	-009	1	\$4.50	
8BR0325-xxx	Deadlatch, RC Front with screws for Entry (EN) lever/knob	-001	-002	-003	-004	-005	-006	-007	-008	-009	1	\$4.50	
8BR0326-001	Deadlatch, DL Collar for Entry (EN) lever/knob	N/A	N/A	N/A	N/A	N/A	N/A	N/A	N/A	N/A	1	\$4.50	
8BR0328-001	Plainlatch/Deadlatch Backplate	N/A	N/A	N/A	N/A	N/A	N/A	N/A	N/A	N/A	1	\$4.00	
8BR0329-001	Deadbolt Backplate for Handleset (SC/DC) and deadbolt (SC/DC)	N/A	N/A	N/A	N/A	N/A	N/A	N/A	N/A	N/A	1	\$4.00	

TO ORDER: COMBINE PART NO. AND FINISH SUFFIX EX: 8BR0304-XXX AND -003 = 8BR0304-003

SERVICE PARTS – STRIKES & SCREWPACKS

STRIKES

Part No./Core No.	Item	FINISHES									Qty.	List Price
		003	049	112	150	152	260	481	492	141		
8BR0401-xxx	Dual Strike Kit, Knob/Lever	-001	-002	-003	-004	-005	-006	-007	-008	-009	1	\$5.00
8BR0402-xxx	Dual Strike Kit, Deadbolt	-001	-002	-003	-004	-005	-006	-007	-008	-009	1	\$5.00
8BR0403-xxx	Square Corner, Knob/Lever	-001	-002	-003	-004	-005	-006	-007	-008	-009	1	\$2.50
8BR0404-xxx	Round Corner, Knob/Lever	-001	-002	-003	-004	-005	-006	-007	-008	-009	1	\$2.50
8BR0405-xxx	Square Corner, Deadbolt	-001	-002	-003	-004	-005	-006	-007	-008	-009	1	\$2.50
8BR0406-xxx	Round Corner, Deadbolt	-001	-002	-003	-004	-005	-006	-007	-008	-009	1	\$2.50
8BR0407-xxx	Full Lip, Deadbolt	-001	-002	-003	-004	-005	-006	-007	-008	-009	1	\$2.50
8BR0408-xxx	Extended Lip, Knob/Lever	-001	-002	-003	-004	-005	-006	-007	-008	-009	1	\$2.50
8BR0409-001	Knob/Lever Dust Box	N/A	N/A	N/A	N/A	N/A	N/A	N/A	N/A	N/A	1	\$2.00

SCREWPACKS

Part No./Core No.	Item	FINISHES									Qty.	List Price
		003	049	112	150	152	260	481	492	141		
8BR0516-xxx	Single Cylinder Deadbolt, 1.375" to 1.75"	-001	-002	-003	-004	-005	-006	-007	-008	-009	1	\$1.25
8BR0501-xxx	Single Cylinder Deadbolt, 1.75" to 2"	-001	-002	-003	-004	-005	-006	-007	-008	-009	1	\$1.25
8BR0502-xxx	Single Cylinder Deadbolt, 2" to 2.5"	-001	-002	-003	-004	-005	-006	-007	-008	-009	1	\$1.25
8BR0503-001	Double Cylinder Deadbolt, 1.75" to 2"	N/A	N/A	N/A	N/A	N/A	N/A	N/A	N/A	N/A	1	\$1.75
8BR0504-001	Double Cylinder Deadbolt, 2" to 2.5"	N/A	N/A	N/A	N/A	N/A	N/A	N/A	N/A	N/A	1	\$1.75
8BR0505-xxx	Double Cylinder Deadbolt, Interior Finished Screws	-001	-002	-003	-004	-005	-006	-007	-008	-009	1	\$1.25
8BR0514-xxx	Patio Deadbolt, 1.375" to 2"	-001	-002	-003	-004	-005	-006	-007	-008	-009	1	\$1.25
8BR0515-xxx	Patio Deadbolt, 2" to 2.5"	-001	-002	-003	-004	-005	-006	-007	-008	-009	1	\$1.25
8BR0517-xxx	Handleset Knob/Lever, 1.375" to 1.75"	-001	-002	-003	-004	-005	-006	-007	-008	-009	1	\$1.25
8BR0518-001	Handleset Thru-bolt, 1.375" to 1.75"	N/A	N/A	N/A	N/A	N/A	N/A	N/A	N/A	N/A	1	\$1.25
8BR0506-xxx	Knob/Lever, 1.375" to 2"	-001	-002	-003	-004	-005	-006	-007	-008	-009	1	\$1.25
8BR0512-xxx	Knob/Lever, 2" to 2.5"	-001	-002	-003	-004	-005	-006	-007	-008	-009	1	\$1.50
8BR0507-xxx	Knob/Lever, Half Dummy	-001	-002	-003	-004	-005	-006	-007	-008	-009	1	\$1.25
8BR0508-xxx	Latch Front Screws	-001	-002	-003	-004	-005	-006	-007	-008	-009	1	\$1.25
8BR0509-001	*Entry Knob Set Screw Kit	N/A	N/A	N/A	N/A	N/A	N/A	N/A	N/A	N/A	1	\$4.00
8BR0510-001	*Entry Lever Set Screw Kit	N/A	N/A	N/A	N/A	N/A	N/A	N/A	N/A	N/A	1	\$4.00
8BR0511-001	*PV/PS/FD/HD Set Screw Kit	N/A	N/A	N/A	N/A	N/A	N/A	N/A	N/A	N/A	1	\$4.00

*Set screw kit contains two set screws (exterior and interior)

TO ORDER: COMBINE PART NO. AND FINISH SUFFIX EX: 8BR0501-XXX AND -001 = 8BR0501-001

SERVICE PARTS – MISC. PARTS

MISC. PARTS

Part No./Core No.	Item	FINISHES										PKG Qty.	List Price
		003	049	112	150	152	260	481	492	141			
8BR0601-001	Half Round PS/PV Spindle, 1.375" up to 2"*	N/A	N/A	N/A	N/A	N/A	N/A	N/A	N/A	N/A	N/A	1	\$1.75
8BR0602-001	Half Round PS/PV Spindle, 2" up to 2.5"**	N/A	N/A	N/A	N/A	N/A	N/A	N/A	N/A	N/A	N/A	1	\$1.75
8BR0637-001	Half Round PV Spindle, 1.375" up to 2"***	N/A	N/A	N/A	N/A	N/A	N/A	N/A	N/A	N/A	N/A	1	\$1.75
8BR0638-001	Half Round PV Spindle, 2" up to 2.5"***	N/A	N/A	N/A	N/A	N/A	N/A	N/A	N/A	N/A	N/A	1	\$1.75
8BR0603-xxx	Decorative Handleset Cap	-001	-002	-003	-004	-005	-006	-007	-008	-009	1	\$2.25	
8BR0632-001	Single Cylinder Deadbolt Torque Blade, 1.375" to 1.75"	N/A	N/A	N/A	N/A	N/A	N/A	N/A	N/A	N/A	1	\$2.00	
8BR0604-001	Single Cylinder Deadbolt Torque Blade, 1.75" up to 2"	N/A	N/A	N/A	N/A	N/A	N/A	N/A	N/A	N/A	1	\$2.00	
8BR0605-001	Single Cylinder Deadbolt Torque Blade, 2" up to 2.5"	N/A	N/A	N/A	N/A	N/A	N/A	N/A	N/A	N/A	1	\$2.00	
8BR0633-001	Double Cylinder Deadbolt Torque Blade, Exterior, 1.375" up to 1.75"	N/A	N/A	N/A	N/A	N/A	N/A	N/A	N/A	N/A	1	\$2.00	
8BR0634-001	Double Cylinder Deadbolt Torque Blade, Interior, 1.375" up to 1.75"	N/A	N/A	N/A	N/A	N/A	N/A	N/A	N/A	N/A	1	\$2.00	
8BR0606-001	Double Cylinder Deadbolt Torque Blade, 1.75" up to 2"	N/A	N/A	N/A	N/A	N/A	N/A	N/A	N/A	N/A	1	\$2.00	
8BR0607-001	Double Cylinder Deadbolt Torque Blade, 2" up to 2.5"	N/A	N/A	N/A	N/A	N/A	N/A	N/A	N/A	N/A	1	\$2.00	
8BR0608-001	Double Cylinder Deadbolt Interior Torque Blade	N/A	N/A	N/A	N/A	N/A	N/A	N/A	N/A	N/A	1	\$2.00	
8BR0630-001	Patio Deadbolt Torque Blade, 1.375" up to 2"	N/A	N/A	N/A	N/A	N/A	N/A	N/A	N/A	N/A	1	\$2.00	
8BR0631-001	Patio Deadbolt Torque Blade, 2" up to 2.5"	N/A	N/A	N/A	N/A	N/A	N/A	N/A	N/A	N/A	1	\$2.00	
8BR0609-001	Deadbolt C-Keyway Cylinder Clip (Bag of 50)***	N/A	N/A	N/A	N/A	N/A	N/A	N/A	N/A	N/A	50	\$28.75	
8BR0610-001	Deadbolt SmartKey Cylinder Clip (Bag of 50)***	N/A	N/A	N/A	N/A	N/A	N/A	N/A	N/A	N/A	50	\$28.75	
8BR0611-001	Knob/Lever C-Keyway Cylinder Clip (Bag of 50)***	N/A	N/A	N/A	N/A	N/A	N/A	N/A	N/A	N/A	50	\$28.75	
8BR0612-001	3/32" Hex Wrench	N/A	N/A	N/A	N/A	N/A	N/A	N/A	N/A	N/A	1	\$0.75	
8BR0613-001	Emergency Release Tool	N/A	N/A	N/A	N/A	N/A	N/A	N/A	N/A	N/A	1	\$1.25	
8BR0614-001	Finish Gauge	N/A	N/A	N/A	N/A	N/A	N/A	N/A	N/A	N/A	1	\$25.00	
8BR0617-001	Cylinder Removal Tool	N/A	N/A	N/A	N/A	N/A	N/A	N/A	N/A	N/A	1	\$1.75	
8BR0618-001	Deadbolt spacer	N/A	N/A	N/A	N/A	N/A	N/A	N/A	N/A	N/A	1	\$1.25	
8BR0636-001	HS/DB Thin Door Spacer, 1.375" to 1.75"	N/A	N/A	N/A	N/A	N/A	N/A	N/A	N/A	N/A	1	\$2.25	
8BR0620-001	SmartKey Reset Cradle	N/A	N/A	N/A	N/A	N/A	N/A	N/A	N/A	N/A	1	\$39.00	
8BR0622-xxx	Handleset, Deadbolt Cylinder Cap, Exterior, C-Keyway	-001	-002	-003	-004	-005	-006	-007	-008	-009	1	\$6.00	
8BR0623-xxx	Handleset, Deadbolt Cylinder Cap, Exterior, SmartKey	-001	-002	-003	-004	-005	-006	-007	-008	-009	1	\$6.00	
8BR0624-xxx	Handleset, Deadbolt Cylinder Cap, Interior, C-Keyway	-001	-002	-003	-004	-005	-006	-007	-008	-009	1	\$6.00	
8BR0625-xxx	Handleset, Deadbolt Cylinder Cap, Interior, SmartKey	-001	-002	-003	-004	-005	-006	-007	-008	-009	1	\$6.00	
8BR0626-xxx	Deadbolt Cylinder Cap, Dummy	-001	-002	-003	-004	-005	-006	-007	-008	-009	1	\$6.00	
8BR0635-001	Patio Deadbolt Adapter	N/A	N/A	N/A	N/A	N/A	N/A	N/A	N/A	N/A	1	\$12.00	
8BR0629-001	Cylinder Plug Follower	N/A	N/A	N/A	N/A	N/A	N/A	N/A	N/A	N/A	1	\$4.00	

*Needed for PV knobs and levers manufactured prior to April 2016.

**Needed for PV knobs and levers manufactured after April 2016.

***Order a unit quantity of one (1) to receive 50 cylinder clips.

TO ORDER: COMBINE PART NO. AND FINISH SUFFIX EX: 8BR0603-XXX AND -001 = 8BR0603-001

SERVICE PARTS – THICK DOOR KITS & TURNPIECES

THICK DOOR KITS

Core Part No.	Item	FINISHES										Qty.	List Price
		003	049	112	150	152	260	481	492	141			
8BR0701-xxx	Single Cylinder Handleset	-001	-002	-003	-004	-005	-006	-007	-008	-009	1	\$13.75	
8BR0702-xxx	Double Cylinder Handleset	-001	-002	-003	-004	-005	-006	-007	-008	-009	1	\$13.75	
8BR0703-xxx	Full Dummy Handleset	-001	-002	-003	-004	-005	-006	-007	-008	-009	1	\$1.75	
8BR0704-xxx	Single Cylinder Deadbolt	-001	-002	-003	-004	-005	-006	-007	-008	-009	1	\$5.75	
8BR0705-xxx	Double Cylinder Deadbolt	-001	-002	-003	-004	-005	-006	-007	-008	-009	1	\$5.75	
8BR0706-xxx	Entry Knob/Lever, C-Keyway	-001	-002	-003	-004	-005	-006	-007	-008	-009	1	\$7.00	
8BR0707-xxx	Privacy/Passage Knob/Lever	-001	-002	-003	-004	-005	-006	-007	-008	-009	1	\$4.75	
8BR0708-xxx	Full Dummy Knob/Lever	-001	-002	-003	-004	-005	-006	-007	-008	-009	1	\$1.75	
8BR0709-xxx	Patio Deadbolt	-001	-002	-003	-004	-005	-006	-007	-008	-009	1	\$5.75	

THIN DOOR KITS

Core Part No.	Item	FINISHES										Qty.	List Price
		003	049	112	150	152	260	481	492	141			
8BR0710-xxx	Single Cylinder Deadbolt	-001	-002	-003	-004	-005	-006	N/A	N/A	-009	1	\$32.00	
8BR0711-001	Double Cylinder Deadbolt	N/A	N/A	N/A	N/A	N/A	N/A	N/A	N/A	N/A	1	\$32.00	

INTERIOR DEADBOLT TURNPIECES

Core Part No.	Item	FINISHES										Qty.	List Price
		003	049	112	150	152	260	481	492	141			
8BR0801-xxx	Traditional Round	-001	-002	-003	-004	-005	-006	N/A	N/A	-007	1	\$16.00	
8BR0802-xxx	Traditional Arch	-001	-002	-003	-004	-005	-006	N/A	N/A	-007	1	\$16.00	
8BR0803-xxx	Traditional Square	-001	-002	-003	-004	-005	-006	N/A	N/A	-007	1	\$16.00	
8BR0804-xxx	Contemporary Round	N/A	N/A	-001	-002	N/A	-003	N/A	N/A	-004	1	\$16.00	
8BR0805-xxx	Contemporary Square	N/A	N/A	-001	-002	N/A	-003	N/A	N/A	-004	1	\$16.00	
8BR0806-xxx	Rustic Arch	N/A	N/A	N/A	N/A	N/A	N/A	-001	-002	N/A	1	\$18.50	
8BR0807-xxx	Rustic Square	N/A	N/A	N/A	N/A	N/A	N/A	-001	-002	N/A	1	\$18.50	

BUILDING A SERVICE PART NUMBER

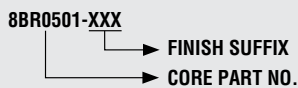

To create service part # combine core and function suffix.
 Example: **8BR0501-001**
 For Single Cylinder screwpack in polished brass (Standard door thickness).

TO ORDER: COMBINE PART NO. AND FINISH SUFFIX EX: 8BR0801-XXX AND -003 = 8BR0801-003

CONDITIONS OF SALE

TERMS: 2%/25 Days, Net 30

SHIPPING: U.S. Customers – F.O.B. Charlotte, NC. Full freight allowed on Baldwin Reserve purchase orders sent through routing of our selection. Delivery is made to curb or dockside only. Freight allowed shipments to Alaska will be prepaid to Seattle, to Hawaii will be prepaid to San Francisco, and to Puerto Rico will be prepaid to Miami. Upon delivery to the transportation company, shipments become the property of the purchasers, who assume full risk for loss or damage in transit.

International Customers – Orders will ship FCA to U.S. city specified on the commercial invoice. Exceptions will be subject to the INCO terms stated on the commercial invoice. Canadian customers should contact their sales representative for variations to these terms.

CLAIMS: All claims, whether referring to errors in prices, filling orders, or for defective goods, must be submitted IN WRITING within 30 days after receipt of shipment. Each claim must be in writing, briefly describe the defect, be accompanied by a proof of purchase and be received during the lifetime of the product or during the period that the original consumer purchaser owns the product. The claimant must provide to his or her Baldwin dealer or retailer other information and evidence reasonably required by Baldwin and, if requested, must permit inspection of the product by Baldwin or its representatives. If, after investigation, Baldwin determines that the claim is valid, the remedy will be performed by or on behalf of Baldwin in accordance with the above heading, "Remedies".

FREIGHT: Baldwin Reserve products are made-to-order and ship within five to seven business days from the time the order is entered, unless otherwise communicated. Baldwin customers can enjoy free 3-day shipping on all orders anywhere in the continental U.S. To expedite shipping, Baldwin also offers expedited freight services for a fee; please contact customer service for details. All shipping lead times are from the date the order is entered into the Baldwin system.

MINIMUM ORDERS: There is no minimum order quantity.

COMBINED ORDERS: Baldwin Reserve orders can be combined with other Baldwin products on the same purchase order; combined orders will ship separately. "Shipping complete" is not available for combined orders of Baldwin Reserve with other Baldwin products.

ORDERS: We reserve the right to decline the whole or part of orders in which the price, finishes or quantity of goods is not satisfactory to us. We reserve the right to discontinue items or change specifications at any time without notice and without incurring any obligations. The corporation cannot be liable for extended delivery dates which may result in the cancellation of an order.

RETURNED GOODS: Returned goods will not be accepted unless authorized in writing by Baldwin within 120 days of invoice date. A minimum of 25% handling charge and freight will be charged on all items returned in original condition. An 80% handling charge will be imposed on all damaged products. Special and custom products are not returnable for credit. No credit will be given for items returned without written authorization, nor will the items be returned to the customer. Authorized returns become void after a period of 30 days from issue date of the Returned Goods Authorization. All credit returns must be shipped to a location specified by Baldwin, FREIGHT PREPAID.

CANCELLATIONS AND CHANGES: While Baldwin will attempt to comply with a customer's request to cancel/change an order, we cannot guarantee this can be accomplished before the factory begins assembly. A 25% handling charge will be applied to cancellations where assembly has started before receipt of a customer's change order request.

PRICES: The list price effective on the date the customer order is received will determine billing price. Prices are subject to change without notice. Orders being held by Baldwin because of account credit status may be re-priced to the price in effect the day the order is released by the Baldwin Credit Department. Orders

requiring delivery in excess of three (3) months will be billed at prices in effect at time of shipment, unless quoted to the contrary in writing by our company.

SPECIFICATIONS: Packing, weights, measurements, and design are subject to change without notice.

Refer to www.baldwinhardware.com for a complete warranty statement.

BALDWIN PORTFOLIO COMPARISON

Baldwin luxury is available in a range of styles, finishes, and price points within the various product portfolios:

Estate, Reserve, and Prestige Series. Whatever your customer's design aesthetic, Baldwin has a product to fit their design needs.

	ESTATE™	RESERVE™	<i>Prestige Series</i>
STYLE & FINISH OFFERING	\$\$\$-\$\$\$\$	\$\$	\$
Knob/Lever Style Options	83	13	4
Rose Style Options	58	7	2
Entry Style Options	68	15	8
Finishes Available	106	9	4
PVD Lifetime Finishes	○	-	-
Lacquer Finishes	○	●	●
Living Finishes	○	-	-
Concealed Screws and Fasteners	●	-	-
PERFORMANCE, OPERATION, APPLICATION			
Lifetime Mechanical Warranty	●	●	●
Tubular Lock Operation	○	●	●
Mortise Lock Operation	○	-	-
Multipoint Application	○	-	-
Emergency Egress Entry	○	-	-
Latch Operation	28° Rotation with Nylon insert for quiet operation	Adjustable Backset	Adjustable Backset
Handle Grip Material	Forged Brass	Forged Brass	Forged Brass
Knob/Lever Material	Forged Brass	Forged Brass	Cast Metal
CYLINDER TECHNOLOGY			
C-Keyway Cylinder	●	●	-
SmartKey® Cylinder	-	○	●
Keyless Entry/Electronic Locks	○	-	-
Master Keying	○	○	-
Construction Keying	○	○	-
Other Specialty Keying	○	-	-
AVAILABLE OPTIONS			
Preconfigured Locksets	Yes	-	Yes
Customization	Yes	Yes	-
Coordinating Home Hardware	Yes	Yes	-
Coordinating Cabinet Hardware	Yes	-	Yes
Primary Ordering	Select Preconfigured A la Carte	Configured	Preset SKUs

● Standard ○ Optional - Not Available

Baldwin Reserve offers additional options to ensure the product meets your project specification.

- Options Include: Door Thickness, Latch, Strike, Cylinder and Keying.
- Add custom options to the product description based on the example format below:

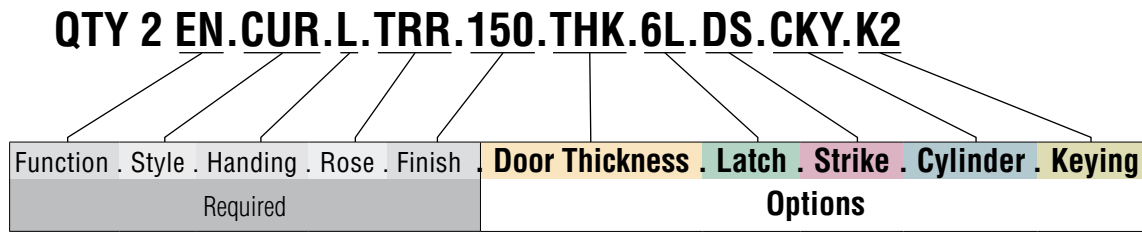

If no options are specified, the product will ship with:

- Standard door thickness
- Square corner adjustable latches
- Square corner strike
- Keyed different (if keyed product)
- C-Keyway cylinder

Door Thickness	Latch	List Price Adder	Strike	List Price Adder	Cylinder	Keying	List Price Adder
Handlesets/Deadbolts 1.75" to 2" Doors	(SL) Square Corner Latch	N/A	(SS) Square Corner Strike	N/A	(CKY) C-Keyway Pin & Tumbler	(KD) Keyed Different	N/A
(STD) Patio Deadbolts 1.375" to 2" Doors	(RL) Round Corner Latch	N/A	(RS) Round Corner Strike	N/A	(SMT) SmartKey (only available on handlesets & deadbolt)	(KA) Keyed Alike (A=#)	N/A
Knobs/Levers 1.375" to 2" Doors	(DL) Drive In Latch	N/A	(DS) Dual Strike Kit	N/A		(CK) Construction Key**	\$5.00
	(6L) 6 Way Latch Kit	N/A	(FS) Full Lip Deadbolt Strike (only available on deadbolt)	N/A		(KC) Key Code	N/A
<i>Handlesets/Deadbolts</i> 2" up to 2.5" Doors	(SLUL) Square Corner UL Latch	\$5.00				(MK) Master Key**	\$5.00
(THK) Patio Deadbolts 2" up to 2.5" Doors	(RLUL) Round Corner UL Latch	\$5.00				(WITH) Separate Lines Keyed Together	N/A
<i>Knobs/Levers</i> 2" up to 2.5" Doors	(DLUL) Drive In UL Latch	\$5.00					
(THN) Handlesets/Deadbolts* 1.375" up to 1.75" Doors							

*Handlesets: Napa and Westcliff styles, SC and DC function only. Deadbolts: Traditional and Contemporary styles, SC and DC function only.
**Construction Key and Master Key not available with SmartKey cylinder.

Orders will ship with default options, in bold above, unless otherwise specified

KEYING

(KD) KEYED DIFFERENT
All keyed locks will ship KD unless otherwise specified.

(KA) KEYED ALIKE
All locks on the same line item are keyed alike.
Example. 2 SC.TRD.150.K2

- Quantity
- The line item represents the deadbolt style and finish.
- K2 represents that the two locks are keyed alike.

(CK) CONSTRUCTION KEYING
Allows a builder to operate a lock during construction. Once the homeowner uses their key, the builder key is rendered inoperable.
Example. SC.TRD.150.CK 35829

- CK indicates the cylinder should be Construction Keyed.
- Represents the builder key code – must be specified when ordering.

(KC) KEY CODE
Keys lock to a specific key-cut
Example. SC.TRD.150.35829

- Represents customer specified key cut.

(WITH) WITH ORDERS
Keys multiple line items of locks together
Example. SC.TRD.150.WITH EN.TRA.TRR.150.K2

- Represents end of bundle and total quantity of locks keyed together.
- Item to be keyed

(MK) MASTER KEYING
Allows multiple keys to operate a single lock. Often used in multi-family applications for owners and tenants.

Allows maintenance access.
Example. SC.TRD.150.MK 59579

- MK indicates the cylinder should be Master Keyed.
- Represents the Master Key Code – must be specified when ordering.

TRADITIONAL	CONTEMPORARY	RUSTIC
HANDLESETS		
 <p>(COL) (NAP) (WES)</p>	 <p>(LAJ) (MIA)</p>	 <p>(ADI) (ELK)</p>
 <p>(CHE) (DEL) (ELI) (NEW)</p>	 <p>(SEA) (SAN)</p>	 <p>(KOD) (LON)</p>
DEADBOLTS		
 <p>(TRD) (TSD) (TAD)</p>	 <p>(CRD) (CSD)</p>	 <p>(RSD) (RAD)</p>
KNOBS/LEVERS		
 <p>(CRY) (ELL) (ROU) (TRA) (CUR) (DEC) (FED)</p>	 <p>(CON) (TUB) (SQU)</p>	 <p>(RUS) (TAP) (ARC)</p>
ROSES		
 <p>(TRR) (TAR) (TSR)</p>	 <p>(CRR) (CSR)</p>	 <p>(RAR) (RSR)</p>
FINISHES		
 <p>003 Polished Brass, 049 Matte Brass & Black, 260 Polished Chrome, 141 Polished Nickel, 150 Satin Nickel, 152 Matte Antique Nickel, 112 Venetian Bronze</p>	 <p>260 Polished Chrome, 141 Polished Nickel, 150 Satin Nickel, 112 Venetian Bronze</p>	 <p>492 White Bronze, 481 Dark Bronze</p>

BALDWIN®

19701 DA VINCI · LAKE FOREST · CALIFORNIA 92610

P. 800.437.7448

F. 800.255.9785

BALDWINHARDWARE.COM