

Bravura

2017 Full Line Catalog and Price Book



Handleset
973
Shown in US15

Bravura

There is something about the feel of solid, forged-brass that can't be duplicated.

It's heavy and strong, yet smooth and comfortable in your hand. That is why Bravura uses solid forged-brass (never cast, hollow, or stamped) throughout its

Forged Series product line.

To enhance the beauty of the forged-brass, skilled Bravura artisans hand-finish each lever, knob, trim, and handleset to a luxurious finish that is both beautiful and durable. Turning a Bravura forged-brass lever or knob gives you the sense they could last for centuries, just like the European designs that inspired them.

Providing Long Lasting Quality You Can Feel.



CRAFTSMANSHIP

Contents



Forged Entry Handlesets

1 - 5

Telluride

6



Forged Passage and Privacy

Traditional

7 - 8

Rustico

9 - 10

Rustico Grande

11 - 12

Moderne

13 - 14

Haute Moderne

15 - 18

Krystal

19 - 20

Keyed Locksets & Deadbolts

21 - 22

Multipoint

23

Mortise Locks

24

Elite Series & Elite Contemporary

25 - 28

Accessories

29

Standard Items & Options

30 - 32

Available Finishes



We are so confident in the quality and reliability of our products that all BRAVURA products receive a Lifetime Mechanical Warranty (see warranty information for full details)



Handleset
980G-1 Non-Handed
Shown in USD10B



Handlesets

Forged Series

Handlesets can be selected with Sectional or Full Interior Trims with no Price Difference



913 Non-Handed
 (PVD, US10B, US15, US26)

Function	
Full Dummy	\$300
Single Keyed	\$300



915 Non-Handed
 (PVD, US10B, US15, US26)

Function	
Full Dummy	\$350
Single Keyed	\$350



919 Non-Handed
 (US10B, US15)

Function	
Full Dummy	\$300
Single Keyed	\$300



916 Non-Handed
 (US10B, US15)

Function	
Full Dummy	\$350
Single Keyed	\$350



970 Non-Handed
 (US10B, US15, US26)

Function	
Full Dummy	\$310
Single Keyed	\$310

Handlesets can be combined with any Interior Trims

HOW TO ORDER HANDLESET EXTERIOR LOCKS

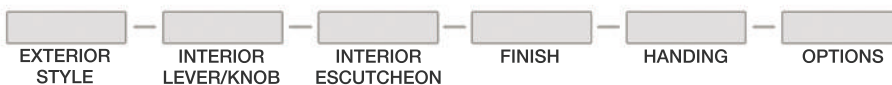

Handlesets

Forged Series



971 Non-Handed
(US10B, US15, US26)

Function	
Full Dummy	\$310
Single Keyed	\$310



980G-1 Non-Handed
(US10B, USD10B, US15, USD15A)

Function	
Full Dummy	\$450
Single Keyed	\$450



980G-2 Non-Handed
(US10B, US15, USD15A)

Function	
Full Dummy	\$450
Single Keyed	\$450

Handlesets can be selected with Sectional or Full Interior Trims with no Price Difference

Handlesets can be combined with any Interior Trims

HOW TO ORDER HANDLESET EXTERIOR LOCKS

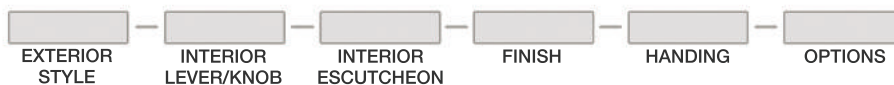



972 Non-Handed
(US10B, US15, US26)
Function
Full Dummy \$310
Single Keyed \$310



990 Non-Handed
(US10B, US15, USD15A, US26)
Function
Full Dummy \$310
Single Keyed \$310



973 Non-Handed
(US10B, US15, US26)
Function
Full Dummy \$310
Single Keyed \$310

*Handlesets
can be selected
with Sectional or
Full Interior
Trims with no
Price Difference*

*Handlesets
can be combined
with any Interior
Trims*

HOW TO ORDER HANDLESET EXTERIOR LOCKS

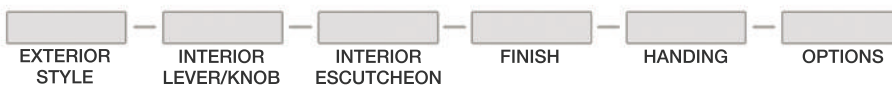

Handlesets Interior Options

Forged Series



-616 Handed
(US10B, US15, USD15A)
Inside Trim - Prefix with any
Lever or Knob selection

*Pick any Lever or
Knob to prefix
any Interior Trims
(for example 904S-616)*



-615 Handed
(PVD, US10B, USD10B, US15, USD15A, US26)
Inside Trim - Prefix with any
Lever or Knob selection



-672 Handed
(US10B, US15, US26)
Interior Trim - Prefix with any
Lever or Knob selection

*Handlesets
can be selected
with Sectional
Interior Trims with
no Price Difference*



-690 Handed
(PVD, US10B, US15, USD15A, US26)
Interior Trim - Prefix with any
Lever or Knob selection

HOW TO ORDER HANDLESET EXTERIOR LOCKS

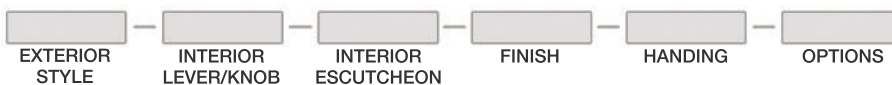

Telluride

Forged Series

Telluride 695 & 696 Escutcheon Size is 9 5/16" X 2 5/8"



Exterior
Cylinder on
Keyed Trim

Inside Thumb-
turn for Keyed
Lockset

**Any Knob
or Lever
can be combined
with Telluride
Trims**

904S-695 Handed
(US10B, USD10B, US15, USD15A)

Function	
Passage/Privacy	\$165
Half Dummy	\$75
Full Dummy	\$150
Single Keyed	\$220



Inside Thumb-
turn for Keyed
Lockset

939-692 Handed
(US10B, US15, US26)

Function	
Passage/Privacy	\$165
Half Dummy	\$75
Full Dummy	\$150
Single Keyed	\$220

Telluride 696 Escutcheon Size is 10 1/2" X 3 1/8"



Exterior
Cylinder on
Keyed Trim

**All Telluride
products
must be
Handed**

904S-696 Handed
(US10B, US15, USD15A)

Function	
Passage/Privacy	\$165
Half Dummy	\$75
Full Dummy	\$150
Single Keyed	\$220



Inside Thumb-
turn for Keyed
Lockset

939-696 Handed
(US10B, US15, USD15A)

Function	
Passage/Privacy	\$165
Half Dummy	\$75
Full Dummy	\$150
Single Keyed	\$220

HOW TO ORDER TELLURIDE LOCKS



Telluride comes standard for 1 3/4" door thickness. Must specify if doors are 1 3/8".

Toll Free (800) 276-1104



Traditional
903-0 Handed
Shown in US15



Traditional -0 Rosette Size is 2 5/8" diameter



900-0 Handed
(PVD, US10B, US15, US26)

Function	
Passage/Privacy	\$102
Half Dummy	\$51



905-0 Non-Handed
(PVD, US10B, US15, US26)

Function	
Passage/Privacy	\$102
Half Dummy	\$51



904-0 Non-Handed
(PVD, US10B, US15, US26)

Function	
Passage/Privacy	\$102
Half Dummy	\$51



904S-0 Non-Handed
(US10B, US15, US26)

Function	
Passage/Privacy	\$102
Half Dummy	\$51



906-0 Non-Handed
(PVD, US10B, US15, US26)

Function	
Passage/Privacy	\$102
Half Dummy	\$51



903-0 Handed
(US10B, US15, US26)

Function	
Passage/Privacy	\$102
Half Dummy	\$51



931-0 Non-Handed
(US10B, US15, US26)

Function	
Passage/Privacy	\$102
Half Dummy	\$51

HOW TO ORDER PASSAGE & PRIVACY

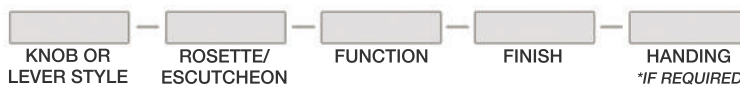



Rustico
904S-1 Non-Handed
Shown in US10B



Rustico -1 & -2 Rosette Size is 3 5/8" x 2 5/8"



903-1 Handed
(US10B, US15, US26)
Function
Passage/Privacy \$118
Half Dummy \$59



904S-1 Non-Handed
(US10B, US15, US26)
Function
Passage/Privacy \$118
Half Dummy \$59



906-1 Non-Handed
(PVD, US10B, US15, US26)
Function
Passage/Privacy \$118
Half Dummy \$59



936-1 Non-Handed
(US10B, US15)
Function
Passage/Privacy \$118
Half Dummy \$59



931-1 Non-Handed
(US10B, US15, US26)
Function
Passage/Privacy \$118
Half Dummy \$59



904-1 Non-Handed
(PVD, US10B, US15, US26)
Function
Passage/Privacy \$118
Half Dummy \$59



937-1 Handed
(US10B, US15, US26)
Function
Passage/Privacy \$118
Half Dummy \$59



905-1 Non-Handed
(PVD, US10B, US15, US26)
Function
Passage/Privacy \$118
Half Dummy \$59



903-2 Handed
(US10B, US15)
Function
Passage/Privacy \$118
Half Dummy \$59



936-2 Non-Handed
(US10B, US15)
Function
Passage/Privacy \$118
Half Dummy \$59

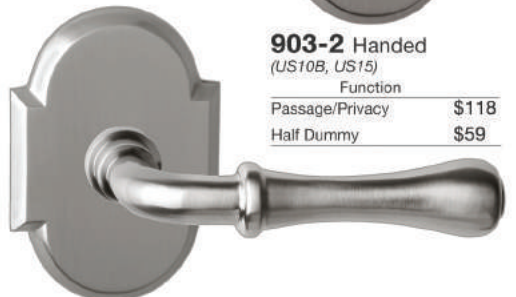

931-2 Non-Handed
(US10B, US15)
Function
Passage/Privacy \$118
Half Dummy \$59



904S-2 Non-Handed
(US10B, US15)
Function
Passage/Privacy \$118
Half Dummy \$59



905-2 Non-Handed
(US10B, US15)
Function
Passage/Privacy \$118
Half Dummy \$59

HOW TO ORDER PASSAGE & PRIVACY





Rustico Grande
909G-1 Handed
Shown in USD10B



Rustico Grande

Forged Series

Rustico Grande G-1 & G-2 Rosette Size is 4 1/2" x 2 1/2"



904SG-1 Non-Handed
(US10B, USD10B, US15, USD15A)
Function
Passage/Privacy \$154
Half Dummy \$77



909G-1 Handed
(US10B, USD10B, US15, USD15A)
Function
Passage/Privacy \$154
Half Dummy \$77



905G-1 Non-Handed
(US10B, USD10B, US15, USD15A)
Function
Passage/Privacy \$154
Half Dummy \$77



931G-1 Non-Handed
(US10B, US15)
Function
Passage/Privacy \$154
Half Dummy \$77



936G-1 Non-Handed
(US10B, USD10B, US15, USD15A)
Function
Passage/Privacy \$154
Half Dummy \$77



939G-1 Non-Handed
(US10B, US15, USD10B, USD15A)
Function
Passage/Privacy \$154
Half Dummy \$77



935G-1 Handed
(US10B, US15)
Function
Passage/Privacy \$154
Half Dummy \$77



906G-1 Non-Handed
(US10B, USD10B, US15, USD15A)
Function
Passage/Privacy \$154
Half Dummy \$77



931G-2 Non-Handed
(US10B, US15)
Function
Passage/Privacy \$154
Half Dummy \$77



936G-2 Non-Handed
(US10B, US15, USD15A)
Function
Passage/Privacy \$154
Half Dummy \$77



909G-2 Handed
(US10B, US15, USD15A)
Function
Passage/Privacy \$154
Half Dummy \$77



904SG-2 Non-Handed
(US10B, US15, USD15A)
Function
Passage/Privacy \$154
Half Dummy \$77



905G-2 Non-Handed
(US10B, US15, USD15A)
Function
Passage/Privacy \$154
Half Dummy \$77

HOW TO ORDER PASSAGE & PRIVACY

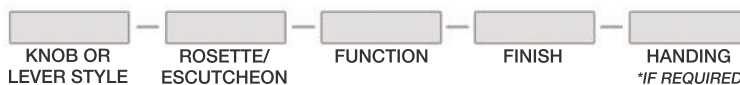



Moderne
945-0 Handed
Shown in US26

Moderne -0 Rosette Size is 2 5/8" diameter



935-0 Handed
(US10B, US15, US26)
Function
Passage/Privacy \$102
Half Dummy \$51



937-0 Handed
(US10B, US15, US26)
Function
Passage/Privacy \$102
Half Dummy \$51



945-0 Handed
(US10B, US15, US26)
Function
Passage/Privacy \$102
Half Dummy \$51



944-0 Non-Handed
(US10B, US15, US26)
Function
Passage/Privacy \$102
Half Dummy \$51



939-0 Non-Handed
(US10B, US15, US26)
Function
Passage/Privacy \$102
Half Dummy \$51



942-0 Non-Handed
(US10B, US15, US26)
Function
Passage/Privacy \$102
Half Dummy \$51

HOW TO ORDER PASSAGE & PRIVACY

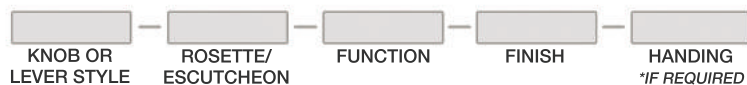



Haute Moderne
935-6 Handed
Shown in US15



Haute Moderne -6 Rosette Size is 2 5/8" diameter



935-6 Handed
(US10B, US15, US26)
Function
Passage/Privacy \$116
Half Dummy \$58



937-6 Handed
(US10B, US15, US26)
Function
Passage/Privacy \$116
Half Dummy \$58



938-6 Non-Handed
(US10B, US15, US26)
Function
Passage/Privacy \$116
Half Dummy \$58



939-6 Non-Handed
(US10B, US15, US26)
Function
Passage/Privacy \$116
Half Dummy \$58



942-6 Non-Handed
(US10B, US15, US26)
Function
Passage/Privacy \$116
Half Dummy \$58

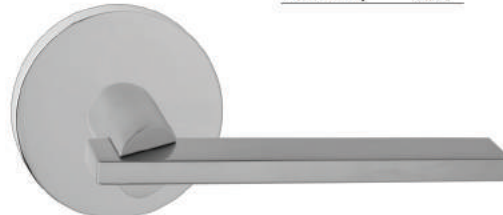

943-6 Non-Handed
(US10B, US15, US26)
Function
Passage/Privacy \$116
Half Dummy \$58



906-6 Non-Handed
(US10B, US15, US26)
Function
Passage/Privacy \$116
Half Dummy \$58



944-6 Non-Handed
(US10B, US15, US26)
Function
Passage/Privacy \$116
Half Dummy \$58



945-6 Handed
(US10B, US15, US26)
Function
Passage/Privacy \$116
Half Dummy \$58



940-6 Non-Handed
(US10B, US15, US26)
Function
Passage/Privacy \$116
Half Dummy \$58



947-6 Non-Handed
(US10B, US15, US26)
Function
Passage/Privacy \$116
Half Dummy \$58

HOW TO ORDER PASSAGE & PRIVACY

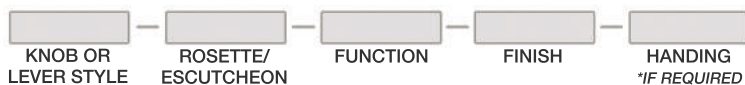



Haute Moderne
943-7 Non-Handed
Shown in US10B

Haute Moderne -7 Rosette Size is 2 5/8" square



935-7 Handed
(US10B, US15, US26)
Function
Passage/Privacy \$116
Half Dummy \$58



937-7 Handed
(US10B, US15, US26)
Function
Passage/Privacy \$116
Half Dummy \$58



938-7 Non-Handed
(US10B, US15, US26)
Function
Passage/Privacy \$116
Half Dummy \$58



939-7 Non-Handed
(US10B, US15, US26)
Function
Passage/Privacy \$116
Half Dummy \$58



940-7 Non-Handed
(US10B, US15, US26)
Function
Passage/Privacy \$116
Half Dummy \$58



942-7 Non-Handed
(US10B, US15, US26)
Function
Passage/Privacy \$116
Half Dummy \$58



906-7 Non-Handed
(US10B, US15, US26)
Function
Passage/Privacy \$116
Half Dummy \$58



943-7 Non-Handed
(US10B, US15, US26)
Function
Passage/Privacy \$116
Half Dummy \$58



945-7 Handed
(US10B, US15, US26)
Function
Passage/Privacy \$116
Half Dummy \$58

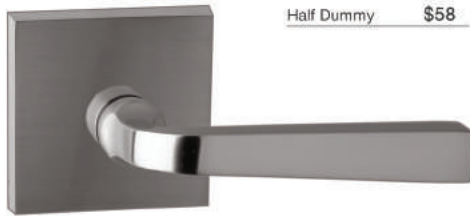

904S-7 Non-Handed
(US10B, US15, US26)
Function
Passage/Privacy \$116
Half Dummy \$58



947-7 Non-Handed
(US10B, US15, US26)
Function
Passage/Privacy \$116
Half Dummy \$58

HOW TO ORDER PASSAGE & PRIVACY

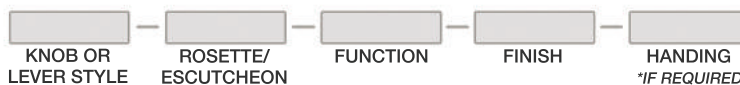



Krystal
925-1 Non-Handed
Shown in US10B



Rosette Size -0, -6, & -7 are 2 5/8" Rosette Size -1 & -2 are 3 5/8" x 2 5/8" Rosette Size G-1 & G-2 are 4 1/2" x 2 1/2"



925-0 Non-Handed
(PVD, US10B, US15, US26)
Function
Passage/Privacy \$148
Half Dummy \$74



926-0 Non-Handed
(PVD, US10B, US15, US26)
Function
Passage/Privacy \$148
Half Dummy \$74



925-6 Non-Handed
(US10B, US15, US26)
Function
Passage/Privacy \$148
Half Dummy \$74



926-6 Non-Handed
(US10B, US15, US26)
Function
Passage/Privacy \$148
Half Dummy \$74



925-7 Non-Handed
(US10B, US15, US26)
Function
Passage/Privacy \$148
Half Dummy \$74



926-7 Non-Handed
(US10B, US15, US26)
Function
Passage/Privacy \$148
Half Dummy \$74



925-1 Non-Handed
(PVD, US10B, US15, US26)
Function
Passage/Privacy \$152
Half Dummy \$76



926-1 Non-Handed
(PVD, US10B, US15, US26)
Function
Passage/Privacy \$152
Half Dummy \$76



925-2 Non-Handed
(US10B, US15)
Function
Passage/Privacy \$152
Half Dummy \$76



926-2 Non-Handed
(US10B, US15)
Function
Passage/Privacy \$152
Half Dummy \$76



925G-1 Non-Handed
(US10B, US15)
Function
Passage/Privacy \$164
Half Dummy \$82



926G-1 Non-Handed
(US10B, US15)
Function
Passage/Privacy \$164
Half Dummy \$82



925G-2 Non-Handed
(US10B, US15)
Function
Passage/Privacy \$164
Half Dummy \$82



926G-2 Non-Handed
(US10B, US15)
Function
Passage/Privacy \$164
Half Dummy \$82

HOW TO ORDER PASSAGE & PRIVACY

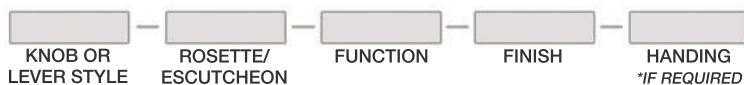

Keyed Locksets

Forged Series



905K-0 Non-Handed
(PVD, US10B, US15, US26)
\$144



903K-0 Handed
(US10B, US15)
\$144



906K-0 Non-Handed
(PVD, US10B, US15, US26)
\$144



903GK-1 Handed
(US10B, US15)
\$182



906GK-1 Non-Handed
(US10B, USD10B, US15, USD15A)
\$182

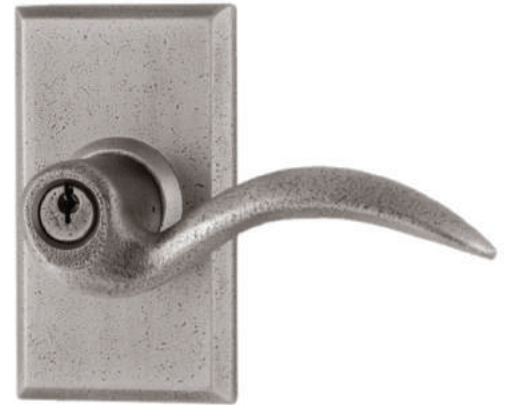

909GK-1 Handed
(US10B, US15, USD10B, USD15A)
\$182



905GK-1 Non-Handed
(US10B, US15, USD10B, USD15A)
\$182



909GK-2 Handed
(US10B, US15, USD15A)
\$182

HOW TO ORDER KEYED LOCKSETS

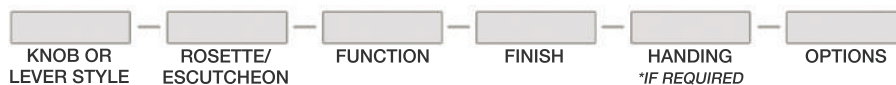

Deadbolts

Forged Series



910-0 Single Keyed \$88
960-0 Double Keyed \$98
910P-0 Patio Bolt \$65
(PVD, US10B, US15, US26)

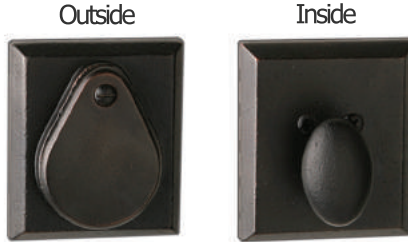

910G-1 Single Keyed \$120
960G-1 Double Keyed \$130
910GP-1 Patio Bolt \$73
(US10B, USD10B, US15, USD15A)

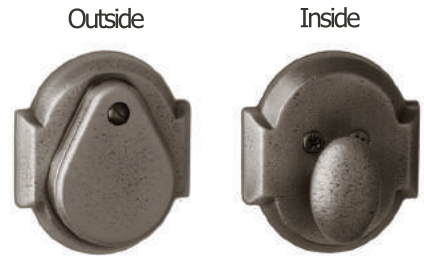

910G-2 Single Keyed \$120
960G-2 Double Keyed \$130
910GP-2 Patio Bolt \$73
(US10B, US15, USD15A)



910-1 Single Keyed \$100
960-1 Double Keyed \$110
910P-1 Patio Bolt \$73
(PVD, US10B, US15, US26)



910-2 Single Keyed \$100
960-2 Double Keyed \$110
910P-2 Patio Bolt \$73
(US10B, US15)



910-5 Single Keyed \$92
910P-5 Patio Bolt \$66
(US10B, US15, US26)



910-6 Single Keyed \$92
960-6 Double Keyed \$102
910P-6 Patio Bolt \$66
(US10B, US15, US26)



910-7 Single Keyed \$92
960-7 Double Keyed \$102
910P-7 Patio Bolt \$66
(US10B, US15, US26)

HOW TO ORDER DEADBOLTS

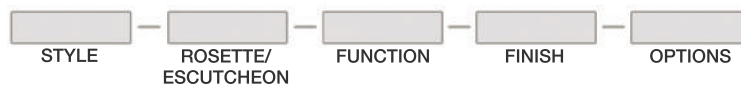

Multipoint

Forged Series

Multipoint Style-1 & Style-2 Escutcheon Sizes are 11" X 1 3/4"

Function	Type	Description	
Function A	Entrance	Active - Keyed with cylinder	\$190
Function B	Patio Bolt	Active - Thumbturn inside no cylinder	\$190
Function C	Dummy/Passage	Active Inside Lever no cylinder	\$180
Function D	Dummy	Dummy, fixed lever on both sides no cylinder	\$180
Function E	Passage	Active Inside and Outside no cylinder	\$180



*MP1-1, MP2-1
MP3-1, MP5-1
available in
USD10B*

MP1 Style - Center line of Lever to Cylinder 3 5/8"
(PVD, US10B, US15, USD15A, US26)

US Cylinder, Lever High

For: GU, Marvin Integrity, Pella, Sierra Pacific, Superior, etc.

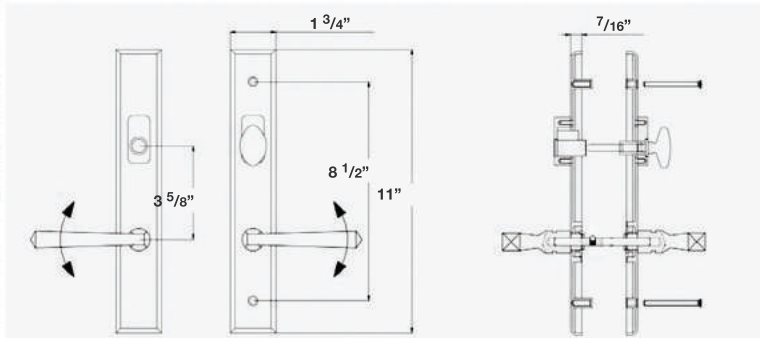
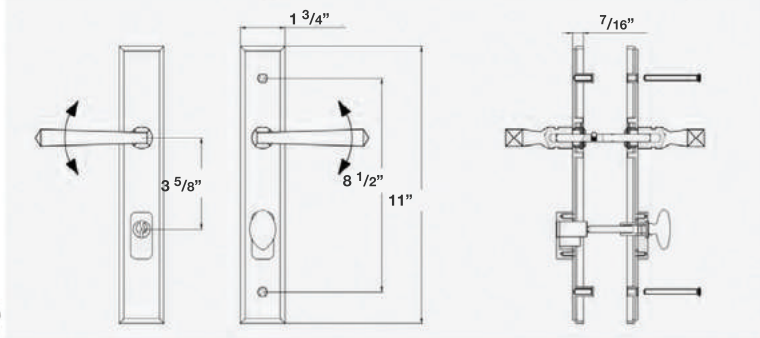

MP2 Style - Center line of Lever to Cylinder 3 5/8"
(PVD, US10B, US15, USD15A, US26)

US Cylinder, Lever Low

For: BiltBest, Eagle, GU, Marvin, etc.

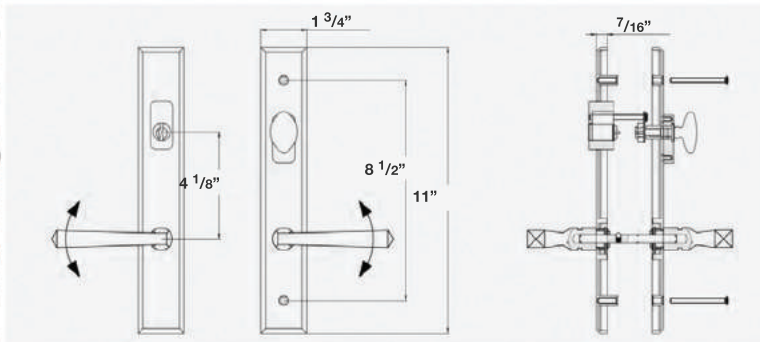

MP3 Style - Center line of Lever to Cylinder 4 1/8"
(PVD, US10B, US15, USD15A, US26)

US Cylinder, Lever Low

For: Andersen

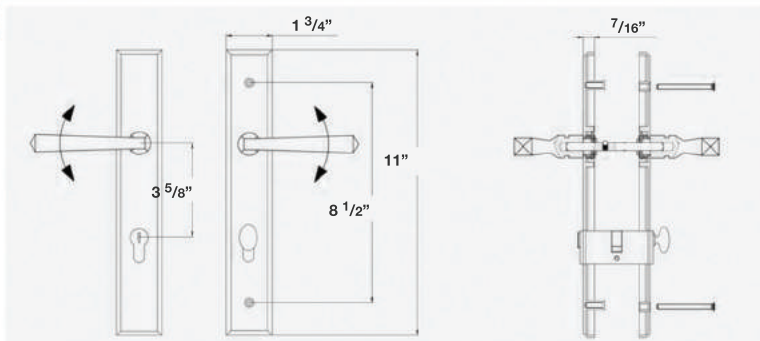

MP5 Style - Center line of Lever to Cylinder 3 5/8"
(PVD, US10B, US15, USD15A, US26)

Euro Cylinder, Lever High

For: Hoppe, Jen-Weld, Kolbe&Kolbe, Lincoln, Loewen, Norco, Peachtree, Pozzi, Semco, Sierra Pacific, Therma-Tru, Vetter, Wathershield, Willmar, Windsor, etc.

In some applications, it may be necessary to drill new mounting through holes

Line Drawings Shown in A Function Only

All Multipoint trims are handed and available with any lever

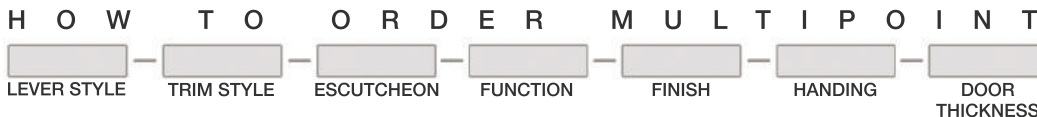

Mortise Locks

Forged Series

Mortise - Lever x Lever UL Rated



904S-695M US15 Shown

Lever x Lever

Telluride 695M
 Trim Handed
 (US10B, USD10B, US15, USD15A)
Telluride 696M
 Trim Handed
 (US10B, US15, USD15A)
 Function
 Entrance (keyed) \$700

Bravura UL-listed mortise locks offer the durability and security that only a Grade 1 mortise lock can provide. They are available in all normal lock functions, and can provide simultaneous retraction (emergency egress) if specified. Installation is via an extra-strong through-bolt system.

Special Order (2 week lead time)

Any Bravura Lever or Knob can be used on Interior Trims

Mortise Interior Escutcheons only available as shown with above corresponding Handlesets

Finish Options Listed are for Mortise Escutcheons Only



937-0 US15 Shown

Lever x Lever
 Sectional Trim Handed
 (US10B, US15, US26) Available Escutcheons:
 Function -0, -6
 All Functions \$682

*Specifications for **Commercial Mortise Locks** with UL Rating:*

- Trim construction:** Solid forged brass, all-metal, integrated springs, no hex screws, through-bolted
- Functions:** All normal functions including: Entrance, Hotel, Classroom and Apartment
- Mortise lock design:** Heavy gauge plated steel case, Grad 1 (Accurate Mfg.) (ANSI/BHMA-A156.3)
- Latch bolt:** Heavy-duty, solid brass, anti-friction type, 3/4" throw
- Mortise lock listing:** 3 hour - UL rating (UL #R13846)
- Lock backset:** 2 1/2" and 2 3/4"
- Deadbolt:** Brass, with hardened steel inserts, 1" throw
- Spindle size:** 8mm, split
- Door thickness:** 1 3/4"
- Latch face:** 1 1/4" x 8", solid brass, bronze, or stainless steel, adjustable for bevel
- Strike:** 4 7/8" ASA
- Installation:** Via exposed screws on trim
- Waranty:** One year





Elite
333B Non-Handed
Shown in US15



Elite

Elite Series

Elite Series is similar in design to our Forged Series, but in high quality Zinc to reduce weight and cost



330B Handed
(PVD, US10B, US15, US26)
Function
Passage/Privacy \$76
Half Dummy \$38



336B Non-Handed
(PVD, US10B, US15, US26)
Function
Passage/Privacy \$76
Half Dummy \$38



337B Handed
(PVD, US10B, US15, US26)
Function
Passage/Privacy \$76
Half Dummy \$38



335B Non-Handed
(PVD, US10B, US15, US26)
Function
Passage/Privacy \$76
Half Dummy \$38



334B Non-Handed
(PVD, US10B, US15, US26)
Function
Passage/Privacy \$76
Half Dummy \$38



333B Non-Handed
(US10B, US15, US26)
Function
Passage/Privacy \$76
Half Dummy \$38

Outside

Inside



310 Single Keyed \$64



360 Double Keyed \$70
(PVD, US10B, US15, US26)

HOW TO ORDER ELITE SERIES

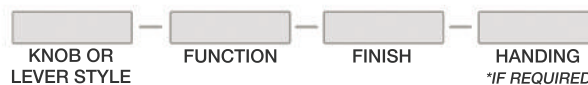



Elite Contemporary
338RC Non-Handed
Shown in US14



Elite

Elite Series

Elite Series is similar in design to our Forged Series, but in high quality Zinc to reduce weight and cost



333RC Non-Handed
(US10B, US15, US14)
Function
Passage/Privacy \$96
Half Dummy \$48



347RC Non-Handed
(US10B, US15, US14)
Function
Passage/Privacy \$96
Half Dummy \$48



338RC Non-Handed
(US10B, US15, US14)
Function
Passage/Privacy \$96
Half Dummy \$48



310RC Single Keyed \$84
360RC Double Keyed \$90
(US10B, US15, US14)



333SC Non-Handed
(US10B, US15, US14)
Function
Passage/Privacy \$96
Half Dummy \$48

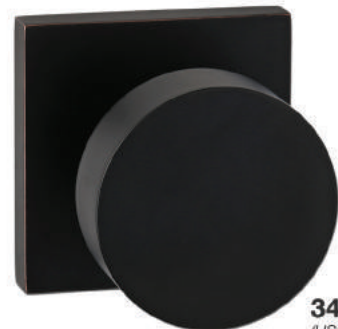

347SC Non-Handed
(US10B, US15, US14)
Function
Passage/Privacy \$96
Half Dummy \$48



338SC Non-Handed
(US10B, US15, US14)
Function
Passage/Privacy \$96
Half Dummy \$48



310SC Single Keyed \$84
360SC Double Keyed \$90
(US10B, US15, US14)

HOW TO ORDER ELITE SERIES

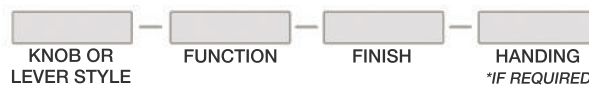



991 - Hinge Stop
 (PVD, US10B, USD10B, US15, USD15A, US26, US14)
 \$16



Floor Stops
 (PVD, US10B, USD10B, US15, USD15A, US26)
 Sizes

921 Small 1 3/8"	\$13
922 Large 2 3/4"	\$19



920 - Door Stop
 (PVD, US10B, USD10B, US15, USD15A, US26, US14)
 \$11

762



766



Surface Bolts
 (PVD, US10B, USD10B, US15, USD15A, US26)
 Sizes

Long 12"	\$52
Short 6"	\$42



760 - Ball Catch
 (PVD, US10B, USD10B, US15, USD15A, US26)
 \$11



930 - Pocket-Door Locks
 (PVD, US10B, USD10B, US15, USD15A, US26, US14)
 Functions

930 Passage	\$22
930 Privacy	\$24

Standard Items

Passage, Privacy Cylindrical Sets

- 2 3/8" Backset
- Square and 1/4" radius-corner latch faces
- Square and 1/4" radius-corner curved lip strike

Handlesets

- 2 3/8" Backset for latch and deadbolt
- Square and 1/4" radius-corner latch faces
- Square and 1/4" radius-corner curved lip strike
- Square and 1/4" radius-corner strike plates

Door Thickness

- All Passage, Privacy, Keyed Locksets, and Handlesets fit door from 1 3/8" to 1 3/4"
- Deadbolts fit door 1 3/4" as standard and require optional door kit above for 1 3/8" door

Deadbolts, Keyed Cylindrical Sets (Radius not available on Keyed Cylindrical)

- 2 3/8" to 2 3/4" Adjustable Backset
- Square and 1/4" radius-corner latch faces
- Square and 1/4" radius-corner strike plates

Mortise

- 2 1/2" or 2 3/4" Backset (must be specified at time of order)
- ASA strike plate
- Any interior lever style
- Non-UL lock case

Options Optional items needed should be added to standard product prices or may be ordered separately

Optional Strikes (PVD, US10B, USD10B, US15, USD15A, US26)

- 1 1/2" Extended Lip (Square only) **\$9**
- 1 3/4" Extended Lip (Square only) **\$9**
- T-Strike (2 3/4" Curved Lip) **\$9**
- ASA (4 7/8" Curved Lip) **\$11**
- Standard Strike (N/C with lockset) **\$9**

2", 2 1/4", 2 1/2" Cylindrical Door Kits

- Passage/Privacy **\$10**
- Deadbolt **\$10**
- Handleset & Telluride **\$10**
- Keyed Entry **\$15**

2", 2 1/4" Mortise Door Kits

- Mortise Handleset **\$35**

UL Latches (US15, US10B)

- Passage, Deadbolt (90 minute rating) **\$35**
- Keyed Function **\$35**
- Handlesets **\$70**

1 3/8" Thick Door Deadbolt Ring **\$9**

(Only in Forged Series - specify style and finish)

Keying

- Master Key **\$30**
- Construction Cylinder (US10B, US15) **\$30**
- Key Alike **\$4**
- Key to Existing Key or # **\$4**
- Bravura Cylinder only **\$30**
- Key Blanks **\$5**

Split Finishes/Styles

- Privacy, Passage, Deadbolt **\$25**
- Keyed Functions **\$35**

(Split finish/style pricing is based on the higher-priced finish or style)

* Elite Series cannot be split

- Door/Hinge Stop Rubber Tips **\$3**
(specify black or white)

- Privacy Pins Only (specify finish) **\$5**
- Privacy Un-Lock Key **\$10**

Latchbolts (no charge if ordered with lock)

- 2 3/8" Backset Standard **\$25**

Latchbolts - Optional

- 2 3/4" Backset (n/c if ordered with lock) **\$25**
- 2 3/8" Drive-In (n/c if ordered with lock) **\$25**
- 2 3/4" Drive-In (n/c if ordered with lock) **\$25**

Lock Handing

Hand is always determined from the outside (secured side) of door

In-Swinging Doors



Out-Swinging Doors

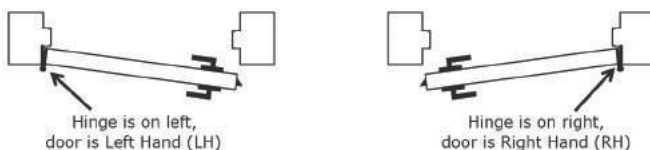

Function Descriptions

Function Name

Description

Passage	Both sides always unlocked.
Privacy	Push-button inside locks outside.
Half Dummy	Inactive one side only, used as door pull handle.
Full Dummy	Inactive both sides, used as pull/push handle. Upon Request.
Entrance	Turn-button inside locks or unlocks outside. Key opens outside if locked.
Double Keyed	Key locks/unlocks both sides.

**Bravura ships most items
within 3 business days.**

Concealed Screw Option

Available in Haute Moderne -6 & -7 Rosettes

To order the Concealed Screw (CS) -6 or -7 option, add CS in options box
when ordering Haute Modern product
Privacy requires handing

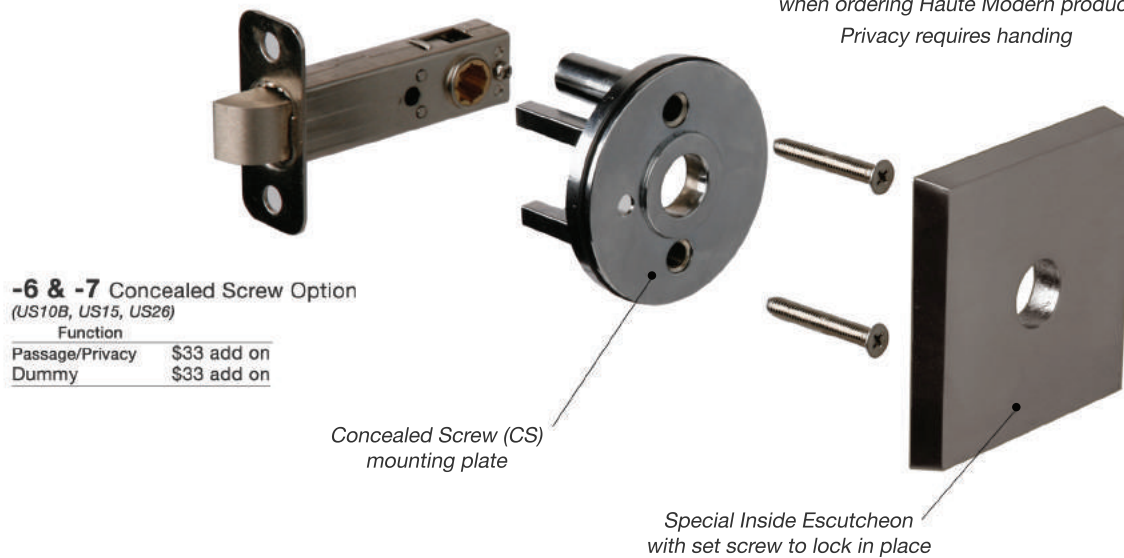

-6 & -7 Concealed Screw Option (US10B, US15, US26)

Function	
Passage/Privacy	\$33 add on
Dummy	\$33 add on

Privacy Pin



Privacy Sets are
supplied with a finish
matched privacy button
(as shown)

Styles and Sizes

Forged Series



900 4 5/8"
(PVD, US10B, US15, US26)



903 4 3/8"
(US10B, US15, US26)



904 4 1/2"
(PVD, US10B, US15, US26)



904S 4 1/2"
(US10B, USD10B, US15, US26, USD15A)



905 2 1/4"
(PVD, US10B, USD10B, US15, USD15A, US26)



906 2 1/8"
(PVD, US10B, USD10B, US15, USD15A, US26)



947 2 1/8"
(US10B, US15, US26)



909 5"
(US10B, USD10B, US15, USD15A)



935 4 3/4"
(US10B, US15, US26)



937 4 7/8"
(US10B, US15, US26)



938 5"
(US10B, US15, US26)



939 5 3/8"
(US10B, USD10B, US15, USD15A, US26)



940 4 9/16"
(US10B, US15, US26)



931 4 1/2"
(US10B, US15, US26)



942 4 7/8"
(US10B, US15, US26)



943 5 1/2"
(US10B, US15, US26)



944 4 1/2"
(US10B, US15, US26)



945 4 9/16"
(US10B, US15, US26)



936 2 1/4"
(US10B, USD10B, US15, USD15A)



-0 2 5/8"
(PVD, US10B, US15, US26)



-1 3 5/8" x 2 5/8"
(PVD, US10B, US15, US26)



-2 3 5/8" x 2 5/8"
(US10B, US15)



-6 2 5/8"
(US10B, US15, US26)



G-1 4 1/2" x 2 1/2"
(US10B, USD10B, US15, USD15A)



G-2 4 1/2" x 2 1/2"
(US10B, US15, USD15A)



-7 2 5/8"
(US10B, US15, US26)

Bravura

Bravura Brass

9190 Corporation Drive

Indianapolis, IN 46256

Tel: 800-276-1104

Fax: 317-598-1020

www.bravurabrass.com

<http://www.facebook.com/bravurabrass/>

<https://twitter.com/BravuraBrass>

<https://www.pinterest.com/bravurabrass/>

<http://www.instagram.com/bravurabrass/>



See Bravura Binder and Website for Warranty Information

Terms and Conditions

Terms: Net 30 Days on established credit. A monthly finance charge, computed on an annual periodic rate of 18% will be added to all past due accounts.

Shipping: Bravura builds product to order and most orders ship within 72 hours. Bravura pays freight on orders above \$1,000 net.

Returned Goods: Bravura items may be returned only with approval from the factory. A factory RMA form must accompany all returns. All returns are to be sent freight prepaid. Returned good are subject to a minimum of 25% handling charge.

Warranty Claims: For warranty service and shipping instructions contact Bravura at: 9190 Corporation Drive, Indianapolis, IN 46256 or call 1-800-276-1104.

For full Terms and Conditions or Technical References please contact Bravura at 1-800-276-1104